



Ministério da
**Ciência, Tecnologia
e Inovação**



sid.inpe.br/mtc-m19/2013/05.06.16.39-NTC

**DOC 200/1 - INTERNATIONAL SPACE STATION (ISS):
SOLIDIFICATION OF LOW MELTING TEMPERATURE
EUTECTIC ALLOY UNDER MICROGRAVITY - SOL**

Chen Ying An
Irajá Newton Bandeira
César Boschetti
Manuel Francisco Ribeiro
Júlio César Peixoto
Rafael Cardoso Toledo

Technical Note.

URL of the original document:
<<http://urlib.net/8JMKD3MGP7W/3E3SJC2>>

INPE
São José dos Campos
2013

PUBLISHED BY:

Instituto Nacional de Pesquisas Espaciais - INPE

Gabinete do Diretor (GB)

Serviço de Informação e Documentação (SID)

Caixa Postal 515 - CEP 12.245-970

São José dos Campos - SP - Brasil

Tel.:(012) 3208-6923/6921

Fax: (012) 3208-6919

E-mail: pubtc@sid.inpe.br

BOARD OF PUBLISHING AND PRESERVATION OF INPE INTELLECTUAL PRODUCTION (RE/DIR-204):**Chairperson:**

Marciana Leite Ribeiro - Serviço de Informação e Documentação (SID)

Members:

Dr. Antonio Fernando Bertachini de Almeida Prado - Coordenação Engenharia e Tecnologia Espacial (ETE)

Dr^a Inez Staciarini Batista - Coordenação Ciências Espaciais e Atmosféricas (CEA)

Dr. Gerald Jean Francis Banon - Coordenação Observação da Terra (OBT)

Dr. Germano de Souza Kienbaum - Centro de Tecnologias Especiais (CTE)

Dr. Manoel Alonso Gan - Centro de Previsão de Tempo e Estudos Climáticos (CPT)

Dr^a Maria do Carmo de Andrade Nono - Conselho de Pós-Graduação

Dr. Plínio Carlos Alvalá - Centro de Ciência do Sistema Terrestre (CST)

DIGITAL LIBRARY:

Dr. Gerald Jean Francis Banon - Coordenação de Observação da Terra (OBT)

DOCUMENT REVIEW:

Marciana Leite Ribeiro - Serviço de Informação e Documentação (SID)

Yolanda Ribeiro da Silva Souza - Serviço de Informação e Documentação (SID)

ELECTRONIC EDITING:

Maria Tereza Smith de Brito - Serviço de Informação e Documentação (SID)

Luciana Manacero - Serviço de Informação e Documentação (SID)



Ministério da
**Ciência, Tecnologia
e Inovação**



sid.inpe.br/mtc-m19/2013/05.06.16.39-NTC

**DOC 200/1 - INTERNATIONAL SPACE STATION (ISS):
SOLIDIFICATION OF LOW MELTING TEMPERATURE
EUTECTIC ALLOY UNDER MICROGRAVITY - SOL**

Chen Ying An
Irajá Newton Bandeira
César Boschetti
Manuel Francisco Ribeiro
Júlio César Peixoto
Rafael Cardoso Toledo

Technical Note.

URL of the original document:
<<http://urlib.net/8JMKD3MGP7W/3E3SJC2>>

INPE
São José dos Campos
2013

LIST OF FIGURES

	<u>Pág.</u>
2.1 SOL experimental apparatus (estimated mass $\cong 1.70$ kg).	4
2.2 Miniature DC Temperature Controller.	4
2.3 Heater set-up showing the electric resistance and quartz ampoules. .	5
2.4 Barriers that in addition to the quartz ampoule form a three barriers system against material sample leakage.	5
2.5 Quartz ampoule with BiInSn alloy.	6
2.6 The Ni-Cr electrical resistance.	7
2.7 SOL experiment section.	7
2.8 Heating and cooling rate of SOL experiment.	8

LIST OF TABLES

	<u>Pág.</u>
2.1 Identification of the SOL experimental parts.	8
3.1 Main requirements for the SOL experiment.	9
3.2 Main Technical requirements.	10

LIST OF ABBREVIATIONS

AEB	–	Brazilian Space Agency
ATP	–	Acceptance Test Program
DAS	–	Data Acquisition System
FS	–	Fuse
INPE	–	Brazilian Institute for Space Research
ISS	–	International Space Station
OP	–	Operations Manua
PI	–	Principal Investigator
TD	–	Technical Description
TS-EQ	–	Technical Specification for Equipment
TS-EX	–	Technical Specification for the Experiment

CONTENTS

	<u>Pág.</u>
1 Introduction	1
1.1 General	1
1.2 Name of the equipment	1
2 Equipment Composition	3
2.1 Experiment objectives under microgravity condition	3
2.2 Experiment description and conduct	3
2.2.1 Safety barriers	5
2.2.2 Sample preparation	6
2.2.3 Electrical resistance	6
2.3 Components list	8
3 Technical Requirements for the Experiment	9
3.1 Experiment duration	9
3.2 Crew time and experimental procedures	9
3.3 Pre-flight requirements	9
3.4 Late access requirements	10
Appendix 01	11

1 Introduction

This document describes the technical specifications for the Solidification Under Microgravity (SOL) of low melting temperature eutectic alloy experiment. The SOL experimental hardware consists of an Electric Heater System (EHS), a Temperature Controller (TC) and a Data Acquisition System (DAS).

1.1 General

The Solidification Under Microgravity (SOL) is an experiment developed by Laboratório Associado de Sensores e Materiais - LAS, of the Instituto Nacional de Pesquisas Espaciais (INPE), located in São José dos Campos, SP, Brazil.

1.2 Name of the equipment

The name of the equipment used for the experiments shall follow the following scheme:

SOL-XXX, where SOL (three letters) is the Acronym for the experiment and XXX represents the designation of a subsystem model according to the following general scheme:

- PF → Protoflight model.

2 Equipment Composition

2.1 Experiment objectives under microgravity condition

The main objective of the SOL experiment is to investigate the influence of microgravity conditions on solidification of low melting temperature alloy. The alloy data information under microgravity experiments will be compared with data information under gravity conditions.

In multiphase alloys, such as eutectic systems, the distribution of the phases in their natural composite structures may produce enhanced anisotropic properties that can be used in a variety of applications. Under microgravity environment, sedimentation and buoyancy are reduced, and the effects of gravitational induced convection on the eutectic microstructure can be better understood.

In systems where the phases are not diffusion-coupled at the interface, like when one phase grows ahead of another phase or when colonies grows at the interface of multi-component alloys, induced convection has a strong influence on the mass transport in the melt. At this project, the goal is to determine the influence of microgravity on the microstructure homogeneity of low melting temperature $Bi_{32.5}In_{51}Sn_{16.5}$ eutectic alloy (melting temperature = 60 °C). The Bi-In-Sn system is an important material for lead-free based alloys for soldering and fusible element for electric protection. A data acquisition system (DAS) will read the data information (temperature) and saved it in a memory card, which must return to Earth with the ISS crewmember.

2.2 Experiment description and conduct

The whole experimental apparatus (Figure 2.1) consists of a heater with a controlled DC resistance, miniature DC Temperature Controller (Figure 2.2 and Appendix 1) and a data acquisition system. The specification and purchase of the data logger is under way. All components are inside a aluminum case (length = 204 mm x diameter = 90 mm). The electric heater system (EHS) can accommodate 3 samples (Figure 2.1) and it is heated up to 75 °C for 45 min, following by cooling with a rate of $\sim 1\text{ }^{\circ}\text{C}/\text{minute}$ during 45 minutes when the electric power is turned off, leaving the apparatus reach room temperature.

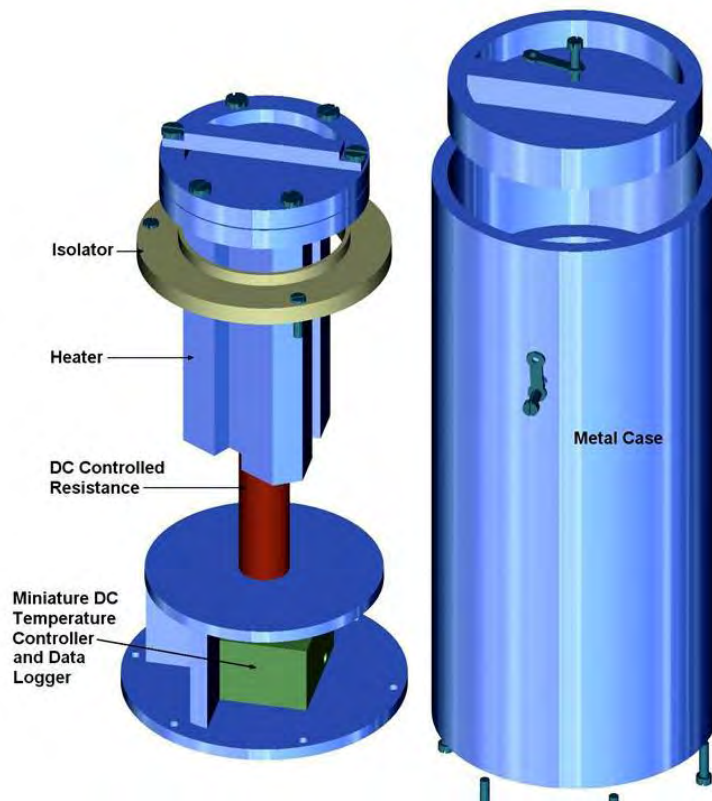

Figure 2.1 - SOL experimental apparatus (estimated mass \cong 1.70 kg).

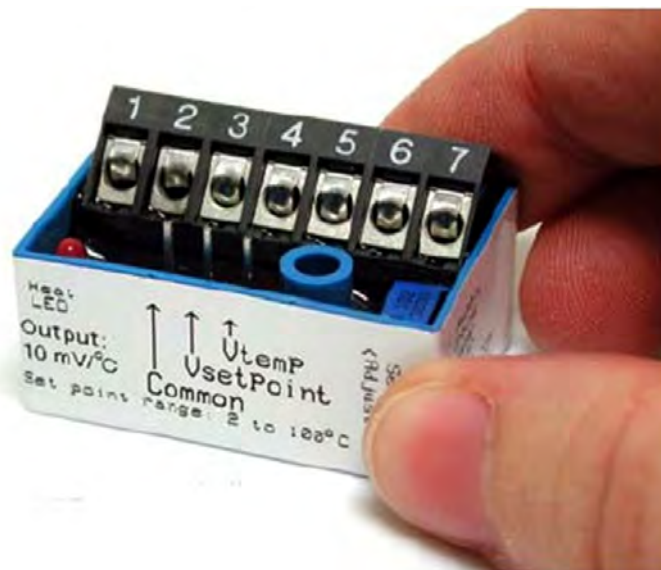

Figure 2.2 - Miniature DC Temperature Controller.



Figure 2.3 - Heater set-up showing the electric resistance and quartz ampoules.

2.2.1 Safety barriers

The electric heater system (EHS), made of aluminum, completely isolates the material sample from the exterior environment. Besides the quartz ampoules that provide a first barrier, there are two more barriers (3 plugs and one o-ring) that make the system completely safe against material leakage to the environment of the Space Station. Figure 2.4 below shows the EHS in more detail with these additional barriers.

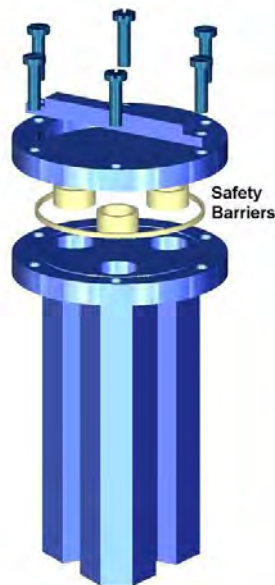

Figure 2.4 - Barriers that in addition to the quartz ampoule form a three barriers system against material sample leakage.

2.2.2 Sample preparation

Each sample alloy is synthesized by using high purity Bi (Bismuth), In (Indium) and Sn (Tin) elements and sealed in an evacuated (pressure lower than 10^{-5} Torr) quartz ampoule ($\phi = 10$ mm, L = 80 mm), Figure 2.5.



Figure 2.5 - Quartz ampoule with BiInSn alloy.

2.2.3 Electrical resistance

The heat is supplied by a Ni-Cr electric resistance encapsulated in a stainless steel cylinder (32Ω , $\phi = 15$ mm, L = 90 mm), Figure 2.6, which is inserted in the bottom side of the electric heater system (EHS), whereas, the three samples are placed inside of the cavities located on the top side. An attached cover is used to keep the samples protected inside the EHS. Temperatures are measured by K-type thermocouples (Figure 2.7) and all thermal informations are recorded in a memory card from a data acquisition system (DAS).

Figure 2.8 shows a graph of temperatures in a laboratory prototype. The system was heated up to $80 \text{ }^\circ\text{C}$ for a security test (in space it will be heat up to only $70 \text{ }^\circ\text{C}$). It clearly shows the latent heat straight lines for heating and cooling process at the alloy fusion temperature of $60 \text{ }^\circ\text{C}$. The black points show the temperature of the external metal case, which did not ultrapassed $30 \text{ }^\circ\text{C}$.

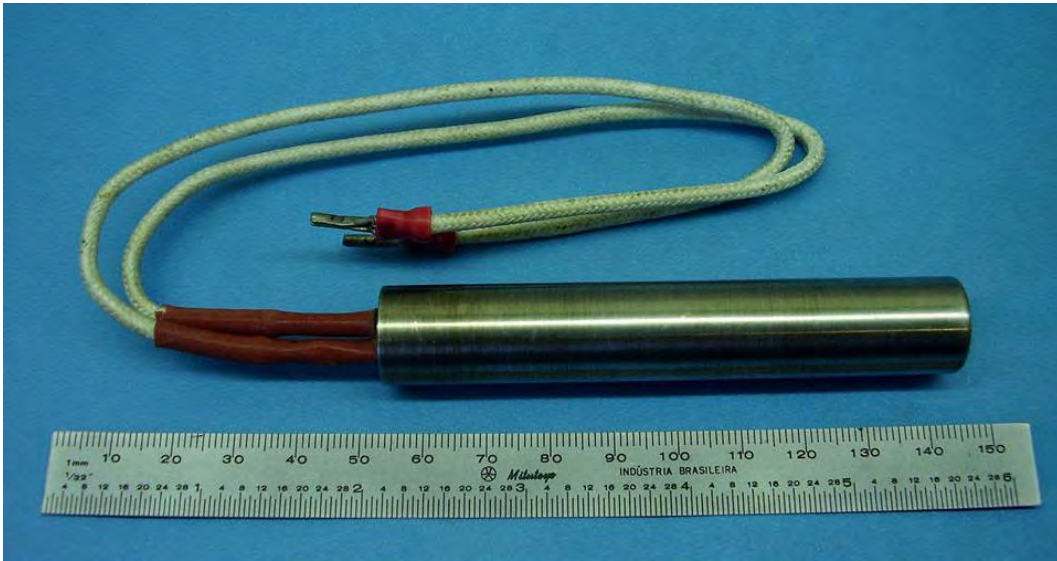

Figure 2.6 - The Ni-Cr electrical resistance.

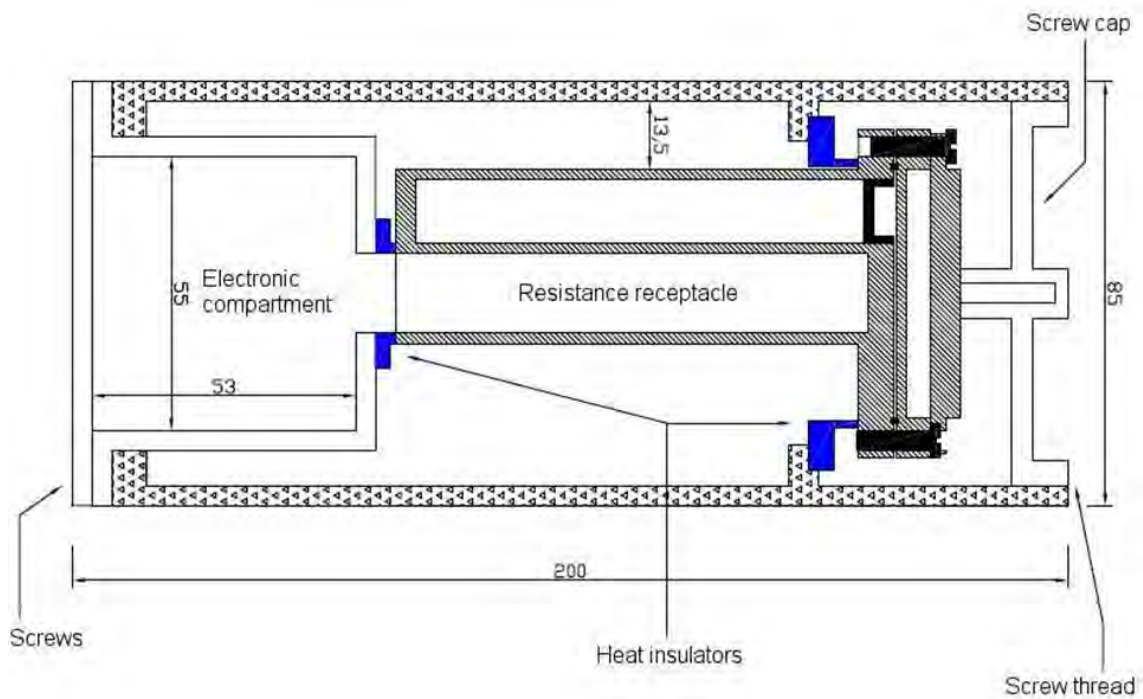

Figure 2.7 - SOL experiment section.

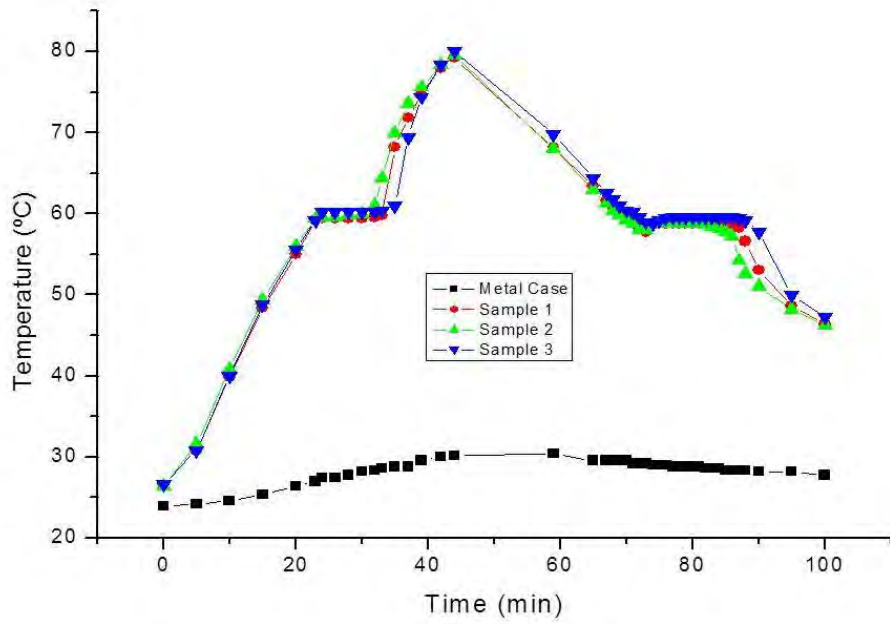

Figure 2.8 - Heating and cooling rate of SOL experiment.

2.3 Components list

The Table 2.1 list the equipments that will be uploaded (launched) and down-loaded (returned).

Table 2.1 - Identification of the SOL experimental parts.

Kit identification description	Configuration Item number	Dimensions L x W x D (mm) or $L \times \phi_{Ext} \times \phi_{Int}$	Weight (g)	Qty	Launch	Return
1. Sample (overall):	3AO-SOL-FM-01	90 x ϕ 12	20	3	-	Yes
Bi-In-Sn Alloy	3AO-SOL-FM-01-01	26 x ϕ 8	10	3	-	Yes
Quartz tube	3AO-SOL-FM-01-02	80 x ϕ 10 x ϕ 8	20	3	-	Yes
2. Experiment Equipment (overall):	3AO-SOL-FM-02	204 x 90 x 80	1700	-	-	-
Metal Case	3AO-SOL-FM-02-01	204 x ϕ 90	1135	1	-	No
Electric Heater System (EHS)	3AO-SOL-FM-02-02	110 x ϕ 66	300	1	-	Yes
Heater Isolator	3AO-SOL-FM-02-03	10 x 80 x 512	42	1	-	No
Heater Support	3AO-SOL-FM-02-04	45 x 90 x 75	170	1	-	No
Electric Resistance	3AO-SOL-FM-02-05	90 x ϕ 15	85	1	-	No
Temperature Controller (TC)	3AO-SOL-FM-02-06	40 x 26 x 26	30	1	-	No
Data Acquisition System (DAS)	3AO-SOL-FM-02-07	-	-	1	-	No
Memory Card	3AO-SOL-FM-02-08	-	-	1	-	Yes
K-Type Thermocouple	3AO-SOL-FM-02-09	170 x ϕ 1	12	4	-	No

3 Technical Requirements for the Experiment

Table 3.1 below summarize the main requirements for the SOL experiment.

Table 3.1 - Main requirements for the SOL experiment.

ITEM	Description or value
Mass up	1700 g
Mass down	400 g
Total Volume up	1300 cm^3
Total current	1 A
Total electric Power	30 W

3.1 Experiment duration

The experiment will be heated for 45 minutes and cool down at a rate of 1 °C per minute during another 45 minutes, totalizing 90 minutes.

3.2 Crew time and experimental procedures

The cosmonaut will switch on and switch off the experiment pressing only one button. After completion and when the experiment is completely at room temperature, the cosmonaut will separate, by unscrewing the electric heater system (EHS) that accommodates the 3 samples and bring it to Earth, leaving the external metal case, the heater resistance and the electronics behind. He also will bring back the memory card.

3.3 Pre-flight requirements

None.

3.4 Late access requirements

None.

Table 3.2 - Main Technical requirements.

	SOLIDIFICATION UNDER MICROGRAVITY - SOL
Mass [kg]	1.7
Volume [cm^3]	1300
Power [W]	30
Current [A]	1
Experiment duration [hour]	1.5
Crew time [hour]	1
Pre-flight requirements	No
Late Access requirements	No
Return mass [kg]	0.4

Appendix 01

CT325 Miniature DC Temperature Controller

Tight control in a small package



Overview

The CT325 Miniature DC Temperature Controller is designed for use with Minco Thermofoil™ heaters and RTD or thermistor sensors. It offers inexpensive on/off temperature control of your process or equipment with accuracy many times better than bimetal thermostats.

You can control temperatures up to 200°C (RTD sensor) or 75°C (thermistor). Easily read and adjust the set point temperature using your voltmeter, then monitor the actual signal temperature at the other end.

Operating from your 4.75 to 60 volt DC power supply, the controller can switch up to 4 amps power to the heater. A bright LED indicates when power is applied to the heater.

The entire unit is epoxy filled for moisture resistance, with a through-hole for a mounting bolt. A terminal block provides the power input, sensor input and heater output connections.

- Tight control with $\pm 0.1^\circ\text{C}$ (0.2°F) deadband
- Miniature package: 1" x 1" x 1.5"
- Solid state on/off control with adjustable setpoint
- Uses standard 100 Ω or 1000 Ω platinum RTD or 50 k Ω thermistor sensor input
- Single DC power source provides power to the controller and heater up to 240 watts
- Simple setup with voltage output pins for process and setpoint temperatures
- 3-wire RTD connection cancels lead resistance

Specifications

Input: 100 Ω or 1000 Ω platinum RTD, 0.00385 Ω/C , 2 or 3-leads, or 50 k Ω NTC thermistor, 2-lead.

Setpoint range: 2 to 200°C (36 to 392°F) for platinum RTD input, 25 to 75°C (77 to 167°F) for thermistor input.

Consult factory for other ranges.

Setpoint stability: $\pm 0.02\%$ of span/°C.

V_{out} signal: 0.010 V/°C overspecified range.

Platinum RTD sensor		Thermistor sensor	
2°C	0.02 V	25°C	0.25 V
50°C	0.50 V	50°C	0.50 V
100°C	1.00 V	75°C	0.75 V
200°C	2.00 V		
Accuracy:	$\pm 1\%$ of span	Accuracy:	$\pm 2\%$ of span
Linearity:	$\pm 0.1\%$ of span	Linearity:	$\pm 2\%$ of span

Deadband: 0.1°C.

Input power: 4.75 to 60 VDC.

Output: Open drain, 4 amps max. DC.

Leadwire compensation: (3-wire RTD) $\pm 0.06^\circ\text{C}/\Omega$ for 100 Ω or 1000 Ω platinum up to 25 Ω per leg.

Fault protection: Heater disabled on RTD short or thermistor open. No heater protection; external fuse is recommended.

Operating ambient temperature range: -40 to 70°C (-40 to 158°F).

Relative humidity: 0 to 95% non-condensing.

Physical: Polycarbonate case, epoxy sealed for moisture resistance.

Weight: 1 oz. (28g).

Connections: Terminal block for wires AWG 22 to AWG 14.

Mounting: Mounting hole for #6 screw through or #8 thread forming screw.

MINCO
A critical component of your success™

CT325 Miniature DC Temperature Controller

Specification options

CT325	Model number
PD	Sensor type from table
I	Power supply: 1 = 4.75 to 10 VDC 2 = 7.5 to 60 VDC
C	Temperature range: A = 25 to 75°C (thermistor only) C = 2 to 200°C (RTD only)
I	Dead band: 1 = 0.1°C
CT325PD1C1 = Sample part number	

Sensor type	Code
100Ω platinum RTD	PD
1000Ω platinum RTD	PF
50 kΩ thermistor	TF

50kΩ thermistor sensor TS66STF is available.

Dimensions in inches (mm)

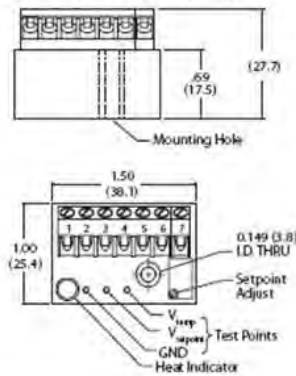

Wiring diagrams

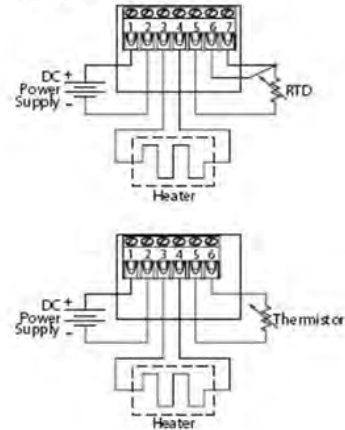

Custom design options

Minco can customize the design of the CT325 for special applications. Specific temperature ranges, other sensor options, and special packaging are possible for volume OEM applications.

AC powered heaters

The CT325 can provide the control signal to an external solid state relay to switch AC power. Use 15 VDC as the control voltage.

