



MINISTÉRIO DA CIÊNCIA E TECNOLOGIA

**INSTITUTO NACIONAL DE PESQUISAS ESPACIAIS**

aa/bb/cc/dd-TDI

## **EFFICIENT STORAGE OF MULTISCALE TRIANGULATED IRREGULAR NETWORKS IN SPATIAL DATABASES**

Eduilson Lívio Neves da Costa Carneiro

Doctorate Thesis at Post Graduation Course in Applied Computing Science,  
advised by Dr. Gilberto Câmara and Dr. Laércio Massaru Namikawa, approved  
in Month XX, 200X.

URL do documento original:  
<<http://urlib.net/xx/yy>>

INPE  
São José dos Campos  
2010

Dados Internacionais de Catalogação na Publicação

---

Carneiro, Eduilson L N C  
Efficient Storage of Multiscale Triangulated Irregular Networks in  
Spatial Databases / Eduilson Lívio Neves da Costa Carneiro. - São  
José dos Campos: INPE, 2010.  
i + 0p. ; (aa/bb/cc/dd-TDI)

Doutorado em Computação Aplicada - Instituto  
Nacional de Pesquisas Espaciais, São José dos Campos, 2010.  
Orientadores: Dr. Gilberto Câmara e Dr. Laércio Massaru

Namikawa.

1. TIN. 2. Multiscale. 3. MNT.  
I. Título.

CDU

Nenhuma parte desta publicação pode ser reproduzida, armazenada em um sistema de recuperação, ou transmitida sob qualquer forma ou por qualquer meio, eletrônico, mecânico, fotográfico, reprográfico, de microfilmagem ou outros, sem a permissão escrita do INPE, com exceção de qualquer material fornecido especificamente com o propósito de ser entrado e executado num sistema computacional, para o uso exclusivo do leitor da obra.

No part of this publication may be reproduced, stored in a retrieval system, or transmitted in any form or by any means, electronic, mechanical, photocopying, recording, microfilming, or otherwise, without written permission from INPE, with the exception of any material supplied specifically for the purpose of being entered and executed on a computer system, for exclusive use of the reader of the work.

## FOLHA DE APROVAÇÃO



*“..uma esmola para um homem que é são, ou lhe mata de vergonha ou vicia o cidadão.”*

*Luiz Gonzaga/ Zé Dantas*



*To my beloved son, João Pedro Ferreira Neves (in memoriam).*





## **ACKNOWLEDGMENTS**

I would like to express my sincere gratitude to my advisers Dr. Gilberto Câmara and Dr. Laércio Massaru Namikawa for their guidance and support through my studies as well as their constructive criticism of my research. They make my PhD study a wonderful experience, both in research and life.

Thanks to my mother Maridéia. Although far from home, I can always feel her love and support. Knowing that she is always there backing me up.

Thanks to my brothers, nephews, aunts, uncles and relatives, by relaxation moments that allowed me regain strength. Especially my sister Auricéia, by support given when I had to leave home to live in São José dos Campos, and to uncles Francisco, Jesus and family for the wonderful welcome in Rio de Janeiro.

Thanks to old friends who understood my absence during this year's, and my new friends and housemates who have made my life so enjoyable. They are Evaldinolia, Sérgio, Vantier, Fred, Kamel, Alexandre, Érica, Flávia, Jeferson, Karla, Adair, Thanisse, Lúbia, Silvana, Renato, Priscila, Danilo, Carolina, Olga, Missae, Pedro, Rosiane and Mrs. Dilza. Special thanks to my dear Giovana, for her love, attention, and our talks about life and world.

Thanks to people who work at LAC, CAP, DPI, and SERE for their support and friendship during the time I was at INPE.

Thanks to IFPI (Federal Institute of Education, Science and Technology of Piauí) for the opportunity provided and financial support, to my friends teachers who have taken classes during my absences. Thanks to CAPES (Coordination for the Improvement of Higher Level Personnel) for financial support.

Thanks to all those who directly or indirectly contributed to the realization of this moment.

And, thanks God, the father and the greatest master.

Thank you!



## **ABSTRACT**

The Digital Terrain Model (DTM) is a digital representation of ground surface topography or terrain. The TIN (Triangulated Irregular Network) is a representation of DTM and it is constructed from a set of irregularly sample points. The number of points controls the complexity of the TIN based model and a higher complexity model needs more point than a less complex ones. The generation of the multiscale TIN based model is achieved by selecting a subset of points used in this generation. This subset must ensure that the produced model has the same features of the full model, such as slope and orientation values. The goal of this work is to shows an efficient storage model of multiscale TIN in spatial database. The multiscale TIN is obtained by defining a ranking on a set of sampling points to create a multiscale TIN which holds the characteristics of the full model.



# ARMAZENAMENTO EFICIENTE DE REDE IRREGULAR TRIANGULAR MULTIESCALA EM BANCOS DE DADOS GEOGRÁFICOS

## RESUMO

O modelo digital de terreno (MDT) é uma representação digital da topografia de um terreno. A grade irregular triangular (TIN – *Triangulated Irregular Network*) é uma representação de MDT que é construída a partir de um conjunto de pontos amostrais irregularmente espaçados. O número de pontos controla a complexidade dos modelos TIN, sendo que modelos mais complexos necessitam de uma maior quantidade de pontos que modelos menos complexos. A geração de modelos TIN multiescala é obtida pela seleção de um subconjunto dos pontos utilizados no modelo completo. Este subconjunto deve assegurar que o modelo produzido tenha as mesmas características do modelo completo, como declividade e orientação. O objetivo deste trabalho é mostrar um modelo eficiente de armazenamento de TIN multiescala em bancos de dados geográficos. O TIN multiescala é obtido através da definição de uma classificação do conjunto de pontos amostrais para criar modelos TIN multiescala que mantenha as características do modelo completo.



## LIST OF FIGURES

	<b><u>Pág.</u></b>
Figure 2.1 – Example of regular grid .....	9
Figure 2.2 – Example of irregular grid .....	11
Figure 2.3 – Decimation criterion a) average plane b) edge criterion .....	16
Figure 2.4 – <i>Feature</i> subtypes.....	20
Figure 2.5 – Geometry class hierarchy.....	21
Figure 2.6 – PolyhedralSurface class.....	21
Figure 2.7 – Coverage subtypes .....	22
Figure 2.8 – <i>Geodatabase</i> elements .....	23
Figure 2.9 – Space representations from feature class .....	23
Figure 2.10 – Terrains data structure .....	24
Figure 2.11 – Levels of detail in terrains pyramid .....	25
Figure 2.12 – Geometric types from Oracle Spatial.....	26
Figure 4.1 – A TIN of (a) Mount Marcy dataset and (b) Brasilia dataset.....	34
Figure 4.2 – Comparison of Multiscale TIN from Mount Marcy dataset with 80% (a) our method (b) MT, 50% (c) our method (d) MT, and 20% (e) our method (f) MT.....	37
Figure 4.3 – Comparison of Multiscale TIN from Brasilia dataset with 60% (a) our method (b) MT, 40% (c) our method (d) MT, and 20% (e) our method (f) MT.....	39
Figure 4.4 – MTE and RMSE slope values for TIN from Mount Marcy with different number of vertexes.....	40
Figure 4.5 – MTE and RMSE aspect values for TIN from Mount Marcy with different number of vertexes.....	41
Figure 4.6 – MTE and RMSE slope values for TIN from Brasilia with different number of vertexes.....	42
Figure 4.7 – MTE and RMSE aspect values for TIN from Brasilia with different number of vertexes.....	43





## ACRONYMS



ANSI	American National Standards Institute
CAD	Computer Aided Design
CORBA	Common Object Request Broker Architecture
DAG	Directed Acyclic Graph
DBMS	Database Management System
DEM	Digital Elevation Model
DGM	Digital Ground Models
DHM	Digital Height Models
DISI	Dipartimento di Informatica e Scienze Dell'informazione
DTM	Digital Terrain Model
ESRI	Environmental Systems Research Institute, Inc
GeoTIFF	Geographic Tagged Image File Format
GIS	Geographic Information Systems
GNU	General Public License
GPS	Global Position System
InSAR	Interferometric Synthetic Aperture Radar
LIDAR	Light Detection and Ranging
LOD	Level of Detail
MT	Multi-Triangulation
MTE	Mean True Error
OGC	Open Geospatial Consortium
ORDBMS	Object Relational Database Management System
RDBMS	Relational Database Management System
RMSE	Root Mean Square Error
SAR	Synthetic Aperture Radar
SQL	Structured Query Language
TIFF	Tagged Image File Format

TIN	Triangulated Irregular Network
VR	Virtual Reality
XML	Extensible Markup Language

# CONTENTS

Pág.

<b>1 INTRODUCTION.....</b>	<b>1</b>
1.1. Motivation.....	2
1.2. Hypothesis .....	2
1.3. General Objective .....	2
1.4. Thesis Layout.....	3
<b>2 RELATED WORK.....</b>	<b>5</b>
2.1. Digital Terrain Model .....	5
2.2. Multiscale Digital Terrain Model .....	14
2.3. Storage of Multiscale TIN .....	19
<b>3 METHODOLOGY.....</b>	<b>29</b>
3.1. Method of Ranking Sample Points .....	29
3.2. Proposed Method.....	31
<b>4 RESULTS .....</b>	<b>33</b>
4.1. Numerical evaluation.....	39
<b>5 CONCLUSION AND FUTURE WORK .....</b>	<b>45</b>
5.1. Main Contributions .....	45
5.2. Future Work .....	45
<b>REFERENCES.....</b>	<b>47</b>



## 1 INTRODUCTION

The digital terrain model (DTM) is a statistical representation of a continuous ground surface composed of many selected points with known X, Y and Z coordinates in an arbitrary coordinate field (Li *et al.*, 2005). DTM is an important way of representing surfaces with their reliefs and morphological features, as well as a useful item for Geographic Information Systems (GIS), Virtual Reality (VR), flight simulators, and military applications.

DTMs are created from remote sensing data, from place measurements on land or through digitalized contour maps. DTMs have two main forms of representations: regular and irregular grids. Among the irregular grids, the irregular triangular grid (TIN - Triangulated Irregular Network) is the best-known. TIN is the digital terrain data in a vector format which represents a network of irregular triangles which do not overlap. The advantage of using TIN instead of other DTM representations is that TIN needs less data for a more accurate terrain representation. Moreover, a better spatial data distribution according to the complexity of the terrain reduces the data for areas with little variation in altitude, such as relief data.

The growing availability of terrain data has allowed the generation of more complex and better quality land models. Thus, the points used in the model affect the quality of TIN. Models created from large numbers of sample points are more complex and have a better resolution. However, the increasing amount of data demands an increase in storage space and computing power.

There are tasks in the same application that need models with varying resolutions. The uses of techniques to create multiscale models come from the need of those applications that use models with different resolutions called multiscale models which capture a wide range of an object detail levels and can be used to rebuild any of those levels on demand. The generation of multiscale

TIN consists of selecting a subset of sample points used in generating a full model.

### **1.1. Motivation**

TIN models are used to represent continuous data such as topography, temperature, geological information, and weather information. These data are directly related to hazard management which can be performed using geotechnology tools (CHAU *et al.*, 2004, MARCELINO, 2007, SANYAL and LU, 2006).

With the technology available in the current Database Management System (DBMS) for managing a large mass of data, forecasting applications, modelling, and spatial analysis have become more dynamic. The integration between DBMS technologies and persistence of TIN models in geographical database will make the use of such data more dynamic, allowing more accurate simulations, predictions, and spatial analyses.

### **1.2. Hypothesis**

Many terrain analyses for hazard management system use slope and aspect measurements, but current techniques to create multiscale models rely on vertical error. This thesis is based on the hypothesis that the storage of multiscale TIN with a simpler structure can provide models that preserve morphological features such as slope and aspect.

### **1.3. General Objective**

This thesis aims to answer the following question: What is the most suitable dataset structure for multiscale TIN storage that enables to retrieve TIN with morphological features?

### **1.3.1. Specific Objectives**

- 1) Develop an indexing method that allows us to build multiscale TIN, which maintains better slope and aspect measurement than those methods based on vertical error.
- 2) Implement the storage of multiscale TIN in spatial databases.

### **1.4. Thesis Layout**

This thesis is organized as follows. The second chapter reviews the work related to this thesis. Section 2.1 shows digital terrain model, where two main forms of representation are shown, they are regular and irregular grids, focusing on TIN. Section 2.2 describes multiscale digital terrain models, showing different approaches for simplification of triangular grids. Section 2.3 presents the adopted solutions by some of the main spatial data storage models to storage TIN. The third chapter shows a new algorithm that evaluates vertex significance and makes a ranking of vertexes and our solution for the storage of TIN. In the fourth chapter we show the achieved results and an assessment of the algorithm in chapter three. Our conclusion and future work are presented in chapter five.





## 2 RELATED WORK

### 2.1. Digital Terrain Model

A digital terrain model (DTM) is an ordered set of sampled data points that represents the spatial distribution of various types of information on the terrain (Li *et al.*, 2005). Thus, DTM uses 2D locations, through coordinates axis ( $X$ ,  $Y$ ), to represent the spatial distribution, and  $Z$  axis to represent the information. It is commonly regarded as a 2.5D representation of the terrain information in 3D geographical space.

There are four groups of information we can represent by DTM:

- a) Landforms, such as elevation, slope, and the other geomorphological features.
- b) Terrain features, such as hydrographical features (rivers, lakes), transport networks (roads, railways).
- c) Natural resources and environments, such as soil, vegetation, geology, and climate.
- d) Socioeconomic data, such as the population distribution in an area, industry and agriculture.

DTM was defined as a digital (numerical) representation of the terrain. But it has other related terms, such as digital elevation model (DEM), digital height models (DHM), digital ground models (DGM). Discussions on the meaning of these terms are found in El-Sheimy (2005), Maune (2001), and Li *et al.* (2005). In this study, DTM refers to landform and terrain feature representations.

The DTMs are created from remote sensing data, field surveying or through digitalized contour maps. Among these, remote-sensing methods there are a larger source of DTM data. DTM data may be calculated by stereoscopic

interpretation of data collected by airborne and satellite sensors. The traditional source of these data is aerial photography which is the most valuable data source for large-scale production of high-quality DTM, delivering elevations to sub-metre accuracy.

Stereoscopic methods have been applied to airborne and space borne synthetic aperture radar (SAR). Space borne lasers can also provide elevation data in narrow swathes (HARDING *et al.*, 1994). In the last few years, new and automated measurement techniques like Airborne Laser Scanning also referred to as LIDAR (light detection and ranging), automated image matching, and interferometric synthetic aperture radar (InSAR) have become available. What all these new techniques have in common is that they allow a dense sampling of the area of interest within a short time. Remote-sensing methods can provide a broad spatial coverage, but have some generic limits. None of the sensors can reliably measure the ground elevations under vegetation cover. Even in the lack of ground cover, all methods measure elevations with significant random errors, depending on the inherent limits of the observing instruments, as well as on the surface slope and roughness (DIXON and R. BARKER, 1998). The methods also need accurately located ground control points to minimise systematic error. Airborne SAR data are available for areas of limited extent.

Field surveying, by using either total station theodolite or GPS (global position system), is a method for measuring terrain surfaces. GPS is replacing the traditional theodolites and total stations. These methods produce specific surface point elevations, including high and low points, saddle points, and points on streams and ridges. The introduction of GPS has increased the availability of accurate ground-surveyed data, but such data are available only for relatively small areas.

Many of the contour data have been digitised from existing topographic maps which are the only source of elevation data for some parts of the world.

According to Hobbs (HOBBS and MOORE, 1985), the conversion of contour maps to digital form is a major activity of mapping organisations worldwide. Contours can also be produced automatically from photogrammetric stereo models. Contours encode some terrain features, such as points on stream lines and ridges. The main disadvantage of contour data is that they can significantly under sample the areas among contour lines, especially in areas of low relief. Contour data differ from other elevation data sources in that they imply a degree of smoothness of the underlying terrain. The density and the accuracy of the contour lines define the fidelity of the terrain representation given by a contour map. Bonin (2005) and Carrara (1997) show construction of DTM from contour lines and evaluate their impact on terrain features.

DTM is a useful application item of Geographic Information Systems (GIS), Virtual Reality (VR), flight simulators, and military applications. Among the main application areas the following can be highlighted:

- a) creation of topographic maps;
- b) planning and designing of civil, road, and mine engineering;
- c) analysis of visibility from predefined points;
- d) calculation of maps of slope and aspect;
- e) automatic definition of drainage and basins;
- f) remote sensing image interpretation and processing; and
- g) various types of geographical analysis;

DTM has two main forms of representation: regular grids and irregular grids.

### **2.1.1. Regular Grid**

A regular grid is a DTM surface representation which uses rectangular polyhedron faces (Figure 2.1). Regular grid is a matrix of z coordinate altitudes

with x and y coordinates implicit in the grid. The grid resolution is the spacing in X or Y-axis in an arbitrary coordinate field. Both spacing should ideally be fewer than or equal to the shortest distance between two samples with different values.

A regular grid is widely used to represent terrain because it is easier to program and store. However, a fixed resolution is also a disadvantage. The resolution of the regular grid may not adequately model rough areas of the surface while being redundant in smooth areas.

Most applications of topography in digital terrain analysis are based on regular grids. The main advantages of regular grids are the following:

- a) Regular grids use a very small spatially uniform characteristic size, grid mesh, thus making variables from different grid points comparable.
- b) Regular grids are more compact, because plan coordinates are not stored in them.
- c) Calculation of variables using regular grids is essentially faster (other kinds of DTM may also be used).

The main disadvantages of regular grids are the following:

- a) Re-projecting of a regular grid is slow, because the early grid loses its regular structure in a new projection, and should be recalculated (using an interpolation) so;
- b) Difficulty of local changes, because if we insert or remove a point from the sample set, the grid should be redone in its entirety;
- c) Regular grids cannot represent features smaller than the grid resolution, for instance a smaller depression. Regular grid cannot represent the depression information because two neighbour grid

points are at the opposite sides of the depression, that is, the depression is between two grid points.

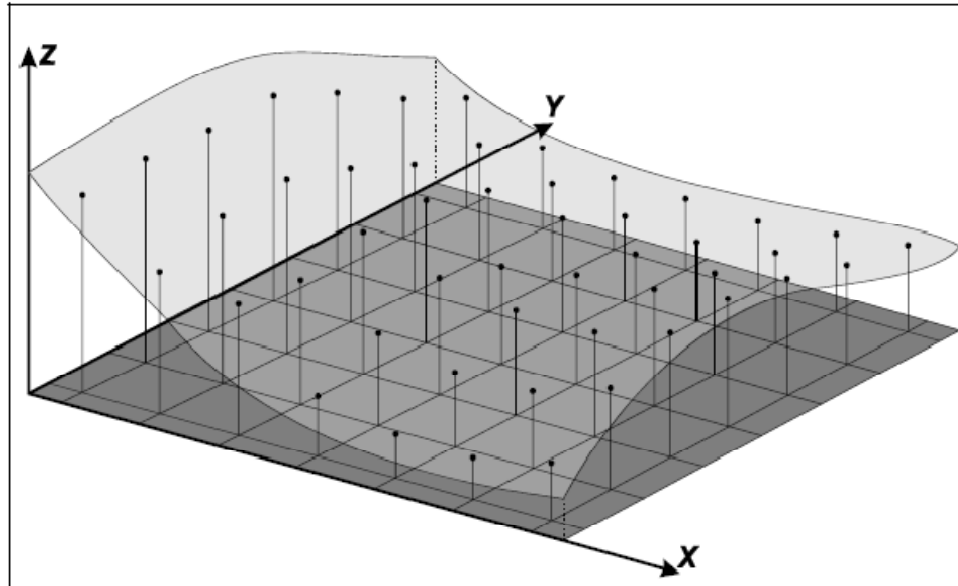

Figure 2.1 – Example of regular grid

Source: adapted from Namikawa (2003)

After setting the resolution and the coordinates of each grid point, we apply interpolation methods to calculate the estimated elevation value of the grid remaining vertices.

Interpolation is a method of building new data points within the range of a discrete set of known data points. Interpolation is needed to produce DTMs from surface-specific points and from contour line data. Since datasets are usually large, high-quality global interpolation methods, such as thin plate splines in which every interpolated point depends explicitly on every data point, are computationally impractical. Such methods cannot be easily adapted to the strong anisotropy evidenced by real terrain surfaces. On the other hand, local interpolation methods, such as inverse distance weighing, local Kriging, and unconstrained triangulation methods, achieve computational efficiency at the expense of arbitrary limits on the form of the fitted surface.

### **2.1.2. Irregular Grid**

Another form of DTM representation is the irregular grid (Figure 2.2), which is a set of irregular polyhedral whose vertexes are the sampled points on the surface topography data. Among the irregular grids, the triangulated irregular network (TIN) is the best-known. TIN is a vector based representation of digital terrain data, made up of irregularly scattered sample points that are arranged in a network of no overlapping triangles. The advantage of using TIN instead of other representations of DTM is that TIN needs less data for a more accurate representation of the terrain. Furthermore, a better spatial distribution of data, according to the complexity of the terrain, reduces the data for areas with little variation in altitude, as in relief data.

According to Mark (1997) and Berg et al. (2000), TIN is a standard model for topography representation in SIG and other softwares. Considering the edges of the triangle, this model allows important morphological information, such as the discontinuities represented by linear relief (Ridges) and drainage (valleys), are considered during the generation of triangular grids. Thus, enabling to model the land surface preserving the morphological features of the surface.

The accuracy of the models represented by TIN is directly related to the quality of sampling, that is, the cost of the model has a direct relationship with the reliability of the samples (MAUNE, 2001). For example, to represent areas with large variations in topography through a TIN model, it needs, a larger number of sample points in areas with fewer variations in topography.

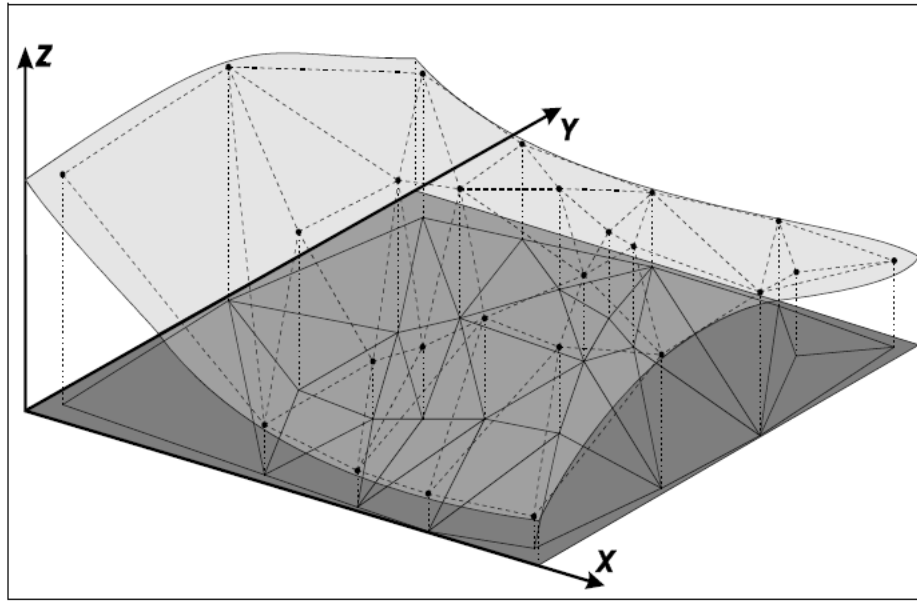

Figure 2.2 – Example of irregular grid

Source: adapted from Namikawa (2003)

According to Preparata and Shamos (1985), a definition for triangulation is: Let  $P = \{p_i = (x_i, y_i), 1 \leq i \leq n\}$  be a set of  $N$  distinct points, irregularly spaced, in a two-dimensional Euclidean space. Let  $CH(P)$  be the convex hull of the set  $P$ , that is the smallest convex polygon in Euclidean space containing all the points of  $P$ . Let  $t = (V_1, V_2, V_3)$  be a triangle formed by vertexes  $V_1, V_2$  and  $V_3 \in P$ . The set of triangles  $T = \{t_j, 1 \leq j \leq m\}$  is a triangulation of  $P$ , if there are no overlapping triangles, and there may be sharing vertexes and edges, and each inner region of  $CH(P)$  belonging to a triangle of  $T$ .

The set  $P$  represents the sampling points of the variable or phenomenon in question, which will be modelled by TIN. Each sample consists of a position and a value that represents the occurrence of the phenomenon on this position. For example, to the Cartesian coordinate system  $X, Y, Z$ , the position can be represented by the pair of coordinates  $X, Y$  and value  $Z$ .

The spatial phenomenon that can be represented by TIN data is relevant temperature, geological information, weather information, among others,

collected in irregular spacing covering the whole surface area to be represented.

According to Namikawa (2003), the Delaunay triangulation is the most widely accepted representation of the surfaces. He cites two properties for a triangulation  $T$  in a Delaunay triangulation:

- a) let's assume that a convex quadrilateral is formed by two adjacent triangles and the common edge of these triangles is a diagonal of the quadrilateral. If this diagonal is replaced with the diagonal of the quadrilateral and the minimum between the six internal angles of triangles does not increase, then this is a Delaunay triangulation (SIBSON, 1978);
- b) for every triangle  $t \in T$ , the triangulation on the set of points  $P$ , formed by the edges  $A_1, A_2$  and  $A_3$  there is a circle  $C$  with a border on the ends of these edges. This circle contains no other points of the set  $P$ . This property is known as the circumcircle property (LI *et al.*, 2005).

According to Li (2005), there are several accepted approaches to build triangulations based on Delaunay triangulation, such as:

- a) **Delaunay Triangulation static vector-based:** In this method, the sample points are all displayed at once. After choosing the starting point it begins to create the triangles sequentially, until all points are interconnected. The choice of threshold follows some approaches: (a) the geometric centre of the sampling points (ILFICK, 1979). (b) the shortest of lines between two points, which makes many process to calculate all the distances between the points and so the least recommended. (c) a line segment in the imaginary boundary for points, this limit can be the bounding



box of points. (d) a line segment on the convex hull of the sample points, which calculates the convex hull can be carried out through various algorithms (REZENDE and STOLFI, 1994) (PREPARATA and SHAMOS, 1985).

- b) **Delaunay Triangulation based dynamic vectors:** insertion of sample points takes place sequentially, which makes the creation of triangulation acquire a dynamic format in which the triangulation is adjusted as new items are added. This method also includes deleting points, retracing the triangulation after each removal. This procedure has complexity of  $O(N^2)$  order in the worst case, but if the search begins by a central point, its complexity is replaced by  $O(N^{3/2})$  (GUIBAS and STOLFI, 1985). The Bowyer-Watson algorithm (BOWYER, 1981, WATSON, 1981) is considered the main algorithm for this triangulation.
- c) **Near-Delaunay Triangulation:** this triangulation is used when we need to insert rows in the model features found. The characteristic lines represent geographical forms that cause a discontinuity surface, such as valleys, crests of mountain regions, and others (NAMIKAWA, 1995). This method follows two properties: (a) the character lines are inserted in a previous triangulation, (b) the result is a triangulation closest to the Delaunay triangulation (LI *et al.*, 2005).
- d) **Delaunay Triangulation by Voronoi diagram:** Voronoi Diagram is a dual of Delaunay Triangulation. After building the Voronoi diagram, the triangulation is carried out by joining the points that share borders the regions of the Voronoi diagram, forming the edges to the Delaunay Triangulation. Therefore, the important question in this method is the Voronoi diagram creation. Let  $P$  be a set of  $N$  points in the plane and  $p_i$  and  $p_j \in P$ . The plane region that is closer to  $p_i$  than to  $p_j$  is the half-plane containing  $p_i$ , which

is a perpendicular bisector to the line segment  $\overline{p_i p_j}$ , called  $H(p_i, p_j)$ . Let  $V(i)$  be the plane region that is closer to  $p_i$  than any other point of  $P$ , then,  $V(i)$  is the intersection of  $N-1$  half-planes and is a convex polygonal region with a maximum  $N-1$  side.

$$V(i) = \bigcap_{i \neq j} H(p_i, p_j) \quad (2.1)$$

Being  $V(i)$  called a Voronoi polygon associated with  $p_i$ , the  $N$  regions of the plan include the Voronoi diagram for the set  $P$ , represented by  $Vor(P)$  (PREPARATA and SHAMOS, 1985). There are several algorithms available for creating the Voronoi diagram, an extensive presentation and evaluation of them can be found at Aurenhammer (1991) and Okabe et al. (2000).

The accuracy of TIN models is directly related to the quality of sampling points, that is, the cost of the model has a direct relationship with the reliability of the samples (MAUNE, 2001). For example, to represent areas with large variation in topography through a TIN model, it needs a larger number of sample points in areas with fewer variations in topography.

Managing such data demands a high processing capacity and memory. TIN multiscale models are widely used to improve performance on views of large expanses of terrain data (XU *et al.*, 2006). In the next section we show multiscale digital terrain models, presenting different approaches for simplification of triangular grids

## 2.2. Multiscale Digital Terrain Model

The term multiscale digital terrain model has been a subject of debate as there is no general agreement on it. For instance, defining scale and resolution in DTM can be difficult. Li (2005) shows arguments that explain the meaning of

both scale and resolution terms. According to him, the term resolution means the size of the basic unit for measurement or representation, while scale means LOD of terrain representation.

There are many papers about terrain representation in literature, where we find the terms "multiscale" (KIDNER *et al.*, 2000) or "multiresolution" (YANG *et al.*, 2005c) to denominate DTM with multiple approximations or levels of detail (LODs). In this work, we use multiscale DTM to refer to a set of approximations of a terrain in different LODs, where each approximation or LOD represents the original terrain model using a different number of polyhedron faces.

According to literature, there has been extensive research about generation and management of LOD models. We can find a review and comparison of mesh simplification algorithms in (CIGNONI *et al.*, 1997, GARLAND, 1999, LINDSTROM and PASCUCCI, 2002). We divide the LOD models into two groups: Regular Grid-based LOD and TIN-based LOD.

Several methods of multiscale modelling on regular grid-based LOD have emerged (CHENG and BASU, 2007, FRANKLIN *et al.*, 2007, LARSEN and CHRISTENSEN, 2003, LINSEN *et al.*, 2007). They are efficient methods for creating regular grid-based LOD models, using a grid of samples equally and periodically spaced in  $x$  and  $y$ . The methods based on quadtree recursively subdivide the surface into regions, building a tree-structured hierarchy.

Lindstrom and Pascucci (2002) show a regular grid-based LOD algorithm based on triangle binary tree, which works recursively subdividing a triangle mesh defined over regularly gridded data using the longest-edge bisection. Kumler (1994) did an extensive comparison of regular grids and general triangulations, and the space and error tradeoffs between them. In this work, we have a special interest in triangular grids.

Different approaches for simplification of triangular grids have emerged in the past years. For instance, vertex decimation (SCHROEDER *et al.*, 1992), edge collapse (YANG *et al.*, 2005a) and wavelet transform (LINSEN *et al.*, 2007).

### 2.2.1. Vertex Decimation

Vertex decimation is an iterative simplification of the triangular grid method, which follows three steps:

- a) select a vertex for removal;
- b) remove from the model all the faces adjacent to the removal vertex;
- c) build the triangle mesh covering the resulting hole of the model.

The key point of this algorithm is the criterion to decide the vertex removal. There are different decimation criteria for vertex decimation algorithms. The criterion based on vertex distance to plane or vertex distance to edge (SCHROEDER *et al.*, 1992) (DE FLORIANI *et al.*, 1998) (CIGNONI *et al.*, 1997) is one of them. In this criterion, if the vertex is within a specific distance to the average plane, (Figure 2.3a) the algorithm removes it, otherwise, it remains. However, if the vertex is on boundary and interior edge (Figure 2.3b), the algorithm uses the distance to edge criterion. In this case, the algorithm calculates the distance to the line defined by the two vertexes creating the boundary or feature edge. If the distance to the line is lesser than  $d$ , the algorithm removes the vertex.

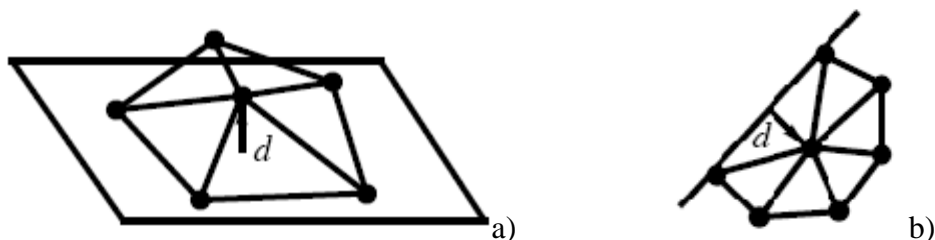

Figure 2.3 – Decimation criterion a) average plane b) edge criterion

Source: adapted from Schroeder (1992)

The vertex decimation algorithm based on quadric error metric (LI and ZHU, 2008) uses the vertex curvature as criterion of simplification to preserve the shape of the original model. That is, if the vertex curvature is large, it can better present the geometric features of a model. Besides curvature, the size of the incident edges around the vertex can also reflect the geometric feature. If the edge length that connects the vertex is large, it affects a larger area on the surface of the model. Li (2008) used both the local curvature and edge length around the vertex to calculate the quadric error metrics, which not only measure distance error but also reflect changes on the model surface. This can preserve many important geometric features and improve overall visual effects after large scale simplifications, while maintaining a lower quadric error.

Little (2003) shows a comparison among the criterion maximum vertical error, root mean squared error and mean absolute error. All these criteria measure the distance towards the normal to the multiscale DTM. Besides, the insertion order by various sums of errors over the triangle is defined, which reduces the size of the TIN for a given approximation error.

### **2.2.2. Edge Collapse**

Edge collapse is a method which follows four steps:

- a) select candidate edges for collapse;
- b) store and encode the vertex relationships;
- c) judge the validity of edge collapse and vertex split, and
- d) evaluate the quality of a model.

In the edge decimation algorithms (ANIL *et al.*, 1997,XU *et al.*, 2006,YANG *et al.*, 2005a), the major difference among these is in selecting the candidate edges and in calculating the errors of the models. For example, Garland and Heckbert (GARLAND and HECKBERT, 1997) used quadric error metrics, Yang *et al.* (2005a,YANG *et al.*, 2005b) decided on the candidate edges according to the distance to the average plane. The edge within the minimum distance to the

average plane will normally collapse first. Calculating the average plane to vertex decimation algorithm follows the proposed method in Schroeder et al. (1992). In addition, Yang used a general bracket method to reduce data storage of multiscale models.

### **2.2.3. Wavelet Transform**

The wavelet-based down sampling non-linear filtering technique allows adaptive simplification of triangular grids. The number of retained wavelet coefficients controls the degree of detail in the simplified model. When using wavelet filters, a visualization method needs to traverse fewer polyhedral faces and to draw fewer triangles to satisfy a certain error bound. Linsen (2007) and BJORKE (2003) show that it is possible to use the adaptive properties of the wavelet method to remove unwanted detail and reduce the information to represent a DTM. That is, it is able to use the wavelet method in model generalization and to view-dependent visualization. According to those studies wavelet filters lessen the approximation error, and reduce the processed polyhedral for visualization purposes.

In Ribelles (2002) we find the summary of the characteristics commonly used to define multiscale methods, moreover it makes the similarities and differences among multiscale methods easily visible.

In general, these methods use vertical measurement associated error as a selection criterion to remove vertexes or edges. However, these methods do not need to insure representation of important terrain morphological information, such as slope and aspect. The aim of these algorithms is to reduce mesh density, but with different goals.

Yang (2008) presents a method for simplifying and compressing data to improve performance in spatial data transmission over the Internet. But, in general, most of the methods developed aim at improving performance when

viewing the triangular grid (DE FLORIANI *et al.*, 2000,GRAY *et al.*, 2003,KIDNER *et al.*, 2000,XU *et al.*, 2006,YANG *et al.*, 2005c). These methods simplify the triangular grid, without the need to insure representation of important terrain morphological information. However, there are some applications that use morphological information and need multiscale models; such as hazard mapping (SANYAL and LU, 2006) and hydrological modelling (RENNÓ, 2005).

In this section, we show the adopted solutions by some of the main spatial data storage models, particularly focusing on TIN storage. We present the multiscale TIN models from Open Geospatial Consortium, ESRI's ArcGIS, Oracle Spatial DBMS, and PostGIS.

## **2.3. Storage of Multiscale TIN**

### **2.3.1. Open Geospatial Consortium - OGC**

The Open Geospatial Consortium (OGC) is an international consortium that brings together businesses, governments, and academic institutions in order to promote interoperability among systems involving spatial information by developing standards for geospatial and location based services. The OGC specification defines various patterns of spatial data. There are two specification categories:

- a) abstract specification – defines geometry models and services excluding details of its implementation, which is independent of the computing platform; and
- b) implementation specification – shows how to implement the concepts of abstract specification using existing technological developments, such as SQL, Java, XML or CORBA.

Feature is an abstract class used as the basis of the OGC's conceptual model. According to the OGC (1998a), Feature is an abstraction of a real-world

phenomenon that when combined with a coordinated position becomes a geographic feature.

Feature class has two main subtypes: Feature with Geometry, which deals with the concept of geo-objects and Coverage, which addresses the concept of geo-fields, besides Other Feature Subtypes (Figure 2.4).

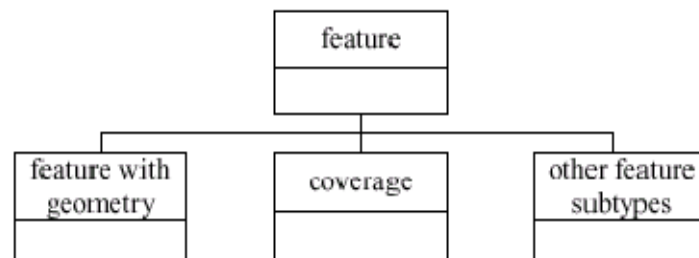

Figure 2.4 – Feature subtypes

Source: OGC (1998b)

Geometry class (Figure 2.5) is an abstract class to represent Feature with Geometry subtype, where we find reference to the TIN model. The TIN class is a subclass from the Polyhedral Surface class. Figure 2.6 shows TIN class in detail.



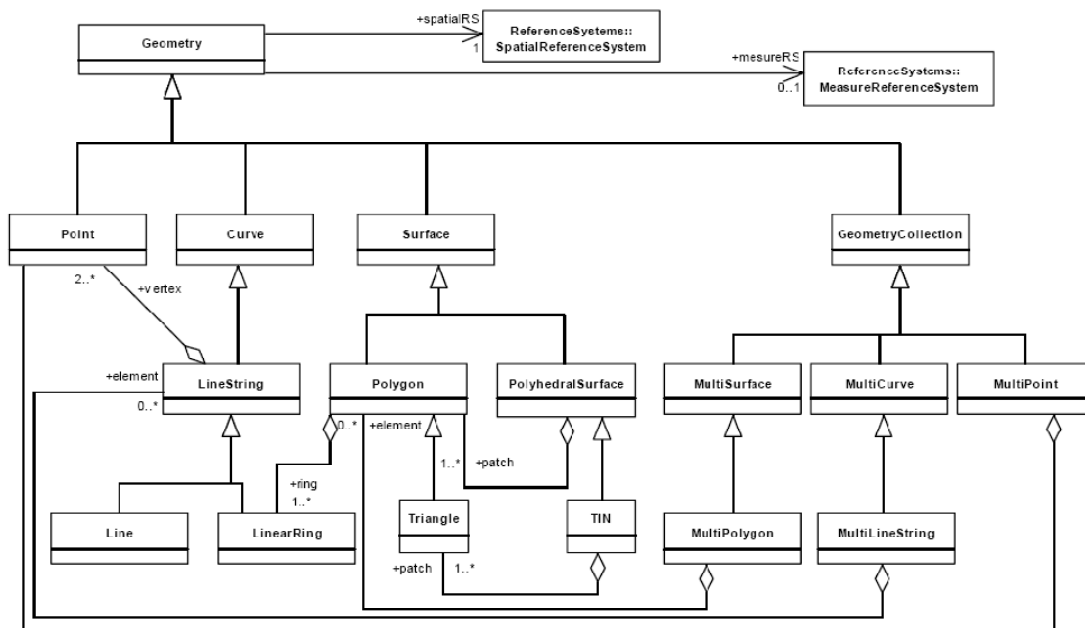

Figure 2.5 – Geometry class hierarchy

Source: OGC (1998a)

TIN class consists of a set of one or more objects from the Triangle class. The Triangle class is a subclass from the Polygon class; each Triangle is a Polygon with three distinct vertexes, not collinear, and without internal borders. We find implementation specification from the Geometry class in OGC (1998a)

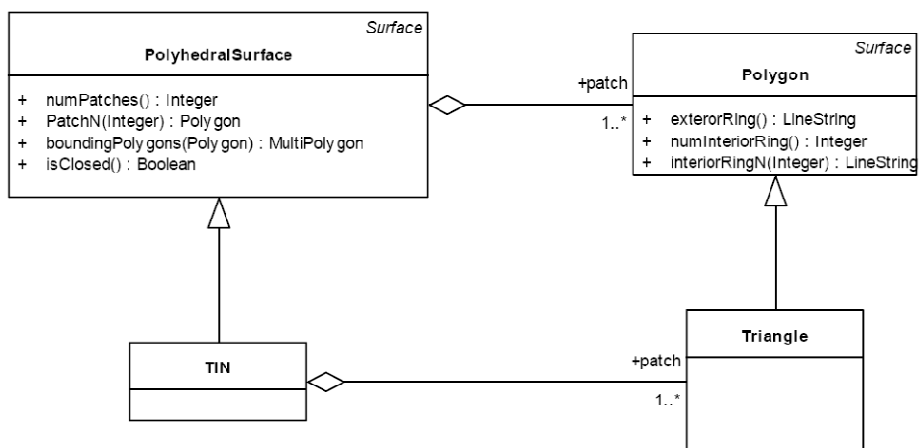

Figure 2.6 – PolyhedralSurface class

Source: OGC (1998a)

Coverage subtype has many subtypes (Figure 2.7), among them a type that represents the TIN model (TIN Coverage subtype). OGC's implementation specifications do not include all subtypes from coverage, and specify only Grid Coverage subtype (OGC, 2001).

Although OGC has specialized two classes for TIN (TIN class and TIN Coverage class) the OGC's abstract specifications do not have references on how to handle multiscale TIN. However, there are some solutions to handle it.

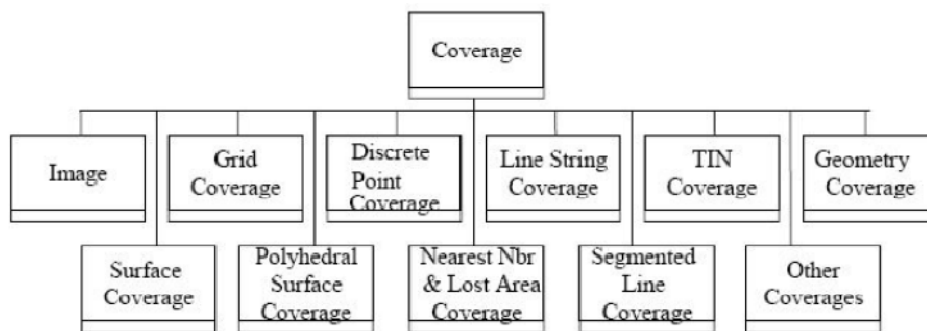

Figure 2.7 – Coverage subtypes

Source: OGC (1998b)

### 2.3.2. ESRI's ArcGIS

ArcGIS is a geographic information system developed by Environmental Systems Research Institute, Inc. - ESRI. ArcGIS uses a particular data structure called Geodatabase (Figure 2.8), which consists of a spatial data collection contained in a folder from a file system, or a Microsoft Access database or an Relational Database Management System (RDBMS) (like Oracle, Microsoft SQL Server, or IBM DB2).

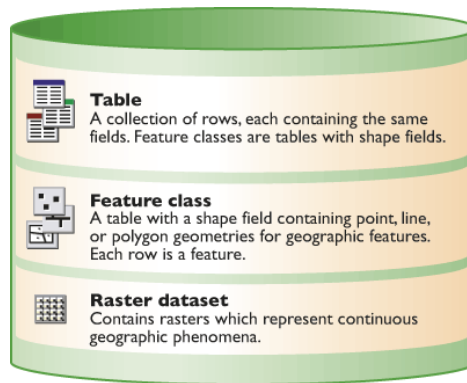

Figure 2.8 – *Geodatabase* elements  
Source: ESRI (2010)

The *Geodatabase* uses three main types of dataset:

- a) Feature Class: homogeneous collection of geographic objects that use the same spatial representation and a common set of attributes, for example, a set of lines to represent roads. The most common representations of spatial feature class are points, lines, polygons, and annotations (the *Geodatabase* name for map text) (Figure 2.9).

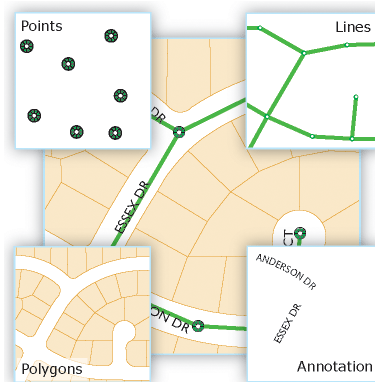

Figure 2.9 – Space representations from feature class  
Source: ESRI (2010)

- b) Raster: represents the geographic features by dividing the world into discrete rectangular or square spaces, organized as a matrix, called cells. Each cell has a value used to represent some characteristic of that location. Raster is used to represent images,

digital elevation models of terrain, and other numerical phenomena.

- c) Tables: attributes are managed in tables that follow the relational data model theory. The column attribute types in the *Geodatabase* include numbers, texts, dates, BLOBs and Global identifiers (GUID or GlobalID), details about each data type can be found in (ESRI, 2010).

ArcGIS *Geodatabase* uses other data formats, such as CAD files (Computer Aided Design), raster files (TIFF, GeoTIFF), and Terrains. A Terrain dataset is a multiscale, TIN-based surface built from measurements stored as features in a *Geodatabase*. Terrain dataset groups data from multiple sources such as LIDAR data, sampling points, breaklines, among others. Terrain dataset records data needed to generate its display. A Terrain dataset organizes the data for fast retrieval and derives a TIN surface on the fly according to user's need (Figure 2.10).

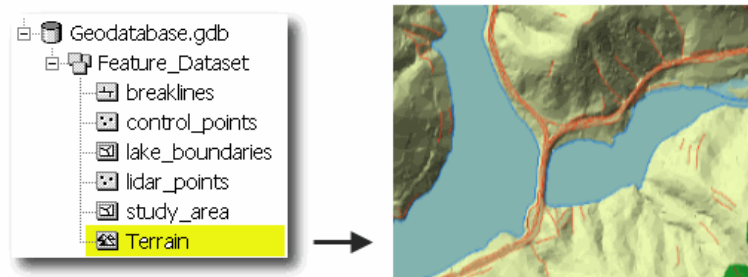

Figure 2.10 – Terrains data structure  
Source: ESRI (2010)

The Terrain model uses the terrain pyramid concept to work with multiple LOD. Terrain pyramid is similar in concept and purpose to raster pyramids, but its implementation is different. There are two pyramid types z-tolerance and window size. The z-tolerance pyramid type utilizes vertical tolerance in the definition of the terrain surface resolution. Each pyramid level is a vertical accuracy approximation of the full-resolution data. Using window size pyramid

type, resolution is defined by equal-area windows at each pyramid level scale range, controlling the horizontal sample density.

The user defines the desired number of pyramid level, with a maximum of seven levels and the area of interest from the database. For each pyramid level, the user defines the collection of data that will be displayed, a working range of map scales for each pyramid level, and the relative accuracy of each pyramid level. Figure 2.11 shows three different LOD of terrains.

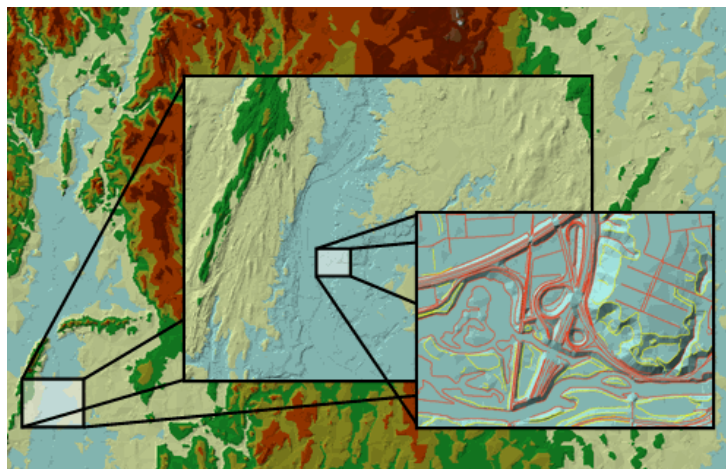

Figure 2.11 – Levels of detail in terrains pyramid  
Source: ESRI (2010)

### 2.3.3. Oracle Spatial

Oracle Spatial (MURRAY, 2009) is a spatial extension based on ORDBMS Oracle. This extension uses OGC's implementation specifications<sup>1</sup>, where each element is associated with a primitive type of spatial data, such as point, line or polygon (with or without hole), as shown in Figure 2.12.

---

<sup>1</sup> OpenGIS Simple Features Specification For SQL Revision 1.1- OpenGIS Project Document 99-049

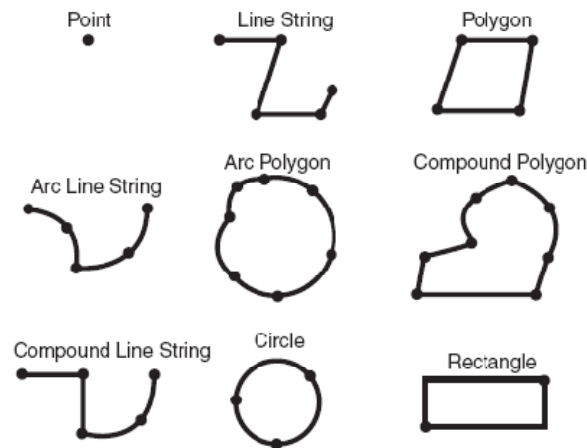

Figure 2.12 – Geometric types from Oracle Spatial  
Source: Murray (2009)

Oracle Spatial offers related object types to support TINs. An SDO\_TIN object models the surface as a network of triangles with no explicit limit on the number of triangles. Oracle Spatial uses the Delaunay triangulation algorithm, if breaklines are not specified.

The description of a TIN is stored in two tables. A “base table” that contains a column with the SDO\_TIN type and that stores the metadata associated with the TIN. The dataset (points) is stored in blocks within another table that is commonly referred to as the “block table”. The “block table” stores both the point information and the triangle information in a BLOB column. Each block storage in “block table” defines its maximum and minimum resolution level at which the block is visible in a query.

Oracle Spatial also offers the SDO\_TIN\_PKG Package a program package to create, store and query TIN. SDO\_TIN\_PKG implements query windows. A window from which to select objects to be returned is typically a polygon for two-dimensional geometries or a frustum for three-dimensional geometries. This query returns triangles from a TIN that are within a specified query window and that satisfy any other requirements specified by the parameters. Oracle Spatial retrieves TIN with LOD by specified resolution parameters in “block table”.

#### **2.3.4. PostGIS**

The PostGIS (RAMSEY, 2007) is a spatial data extension. It is open source, free, supported by ORDBMS PostgreSQL, and developed by Refrations Research Inc. PostGIS supports all data types and functions from OGC's implementation specifications. However, the latest released version is still not in compliance with the latest OGC's specifications version, that is, the treatment of TIN as a storage structure is not possible. Carneiro (2008) shows a model that stores TIN model in PostGIS based on OGC's specification, but without considering multiscale TIN.

#### **2.3.5. Other Storage Models**

Earlier we showed some models of spatial data storage in ORDBMS. The analysis of the main models show that all of them adopt the basic format storage for TIN model in two-dimensional structures, together with storage of numerical variable, for example, altitude.

Another approach for TIN persistence is a treatment by three-dimensional geometric structure. Stoter (2002) presents an assessment of the possibilities of storing 3D data in 2D DBMS, and to propose types of spatial data that meet the needs of more complex spatial queries.

Zlatanova (2006) examines some management options for 3D data points and trends as the evolution from actual DBMS to 3D DBMS. This would allow an improvement in 3D data management, incorporating some basic functions such as volume calculation in 3D DBMS. However, he reports the TIN as still being stored in two-dimensional structure.

Applications as urban planning, environmental monitoring, and telecommunications, have led to research on storage, processing, and analysis of 3D data. Such studies have driven to the creation of 3D GIS, which groups

these demands. Zlatanova (2002,2002) shows a summary of advances in 3D GIS.



### **3 METHODOLOGY**

It is possible to build multiscale TINs using vertex subsets from a triangulation. These subsets are data sources used to build TINs with different LODs from the original triangulation. However, to build TINs with different LODs and to insure that these TINs preserve the terrain features, it is necessary to select the most important vertexes among all those vertexes from the original triangulation.

When a vertex carries information about landform features, such as peaks, pits, valleys, ridges, passes it is the most important one of them all. In a TIN, we use edges to represent terrain landform features. Thus, the vertexes that fix these edges are the most important ones in a triangulation, because they are essential to characterize the terrain. In other words, these vertexes are shared by triangles that have no similar degrees of slope and aspect. Thus removing these vertexes affects the quality of TIN, because they connect polyhedral faces from different geometric plans. Whereas, in regions where the surfaces of adjacent triangles are on common plan, that is, a flat area, to remove a common vertex of these triangles provides a model with fewer vertexes and preserves the important features of the terrain.

Therefore, in order to select a subset with the most important vertex from a triangulation, we must evaluate each vertex significance. In this way, we create an algorithm that evaluates vertex significance and ranks them. From this ranking we can build multiscale TIN with  $N$  vertexes that have higher significance than others.  $N$  is the number of vertexes that a user will need or that can be handled by the system.

#### **3.1. Method of Ranking Sample Points**

According to the chapter above, different approaches for simplification of TIN use vertical measurement associated error as a selection criterion to remove

vertices and edges. As a result, these approaches use assessment based on vertical measurement, which assesses only terrain geometric features.

In this work, we propose a method that assesses how important a vertex is in the triangulation based on slope and aspect from its adjacent triangles. Therefore, we created an algorithm that uses measurements of slope and aspect of adjacent triangles as a criterion to set the ranking sample points.

The algorithm for calculating the significance degree of vertexes is performed for each vertex of the triangulation. The algorithm steps are as follows:

- 1 - Search all triangles adjacent to vertex.
- 2 - Calculate the slope angle (SA), aspect angle (AA) and triangle area (TA) of all adjacent triangles.
- 3 - Calculate the slope factor (SF) (3.1) for all adjacent triangles. The slope factor uses triangle area such as weight, because the larger the triangle the larger the ground surface.

$$SF = SA \times TA \quad (3.1)$$

- 4 - Calculate the significance degree (SD) (3.2).

$$SD = (max(SF) - min(SF)) + (max(AA) - min(AA)) \quad (3.2)$$

Where  $max(SF)$  and  $min(SF)$  are the maximum and minimum slope factor value among all adjacent triangles, respectively. The  $max(AA)$  and  $min(AA)$  are the maximum and minimum aspect angle value among all adjacent triangles, respectively.

We implement this method in the TerraLib library. TerraLib (CÂMARA *et al.*, 2000) is a GIS class and functions library; it also has drivers to access DBMS.

TerraLib is available on the Internet<sup>2</sup> as open source, allowing a collaborative environment and its use for the development of multiple GIS tools. We use its functions to build TIN and store spatial data in a geographical database.

In the next section, we show our solution to storage multiscale TIN in a geographical database and its advantages.

### **3.2. Proposed Method**

The central idea of our method is to store a multiscale TIN in database and to retrieve TIN in different LODs, maintaining the terrain morphological features. According to the solutions shown above, multiscale TIN storage usually needs to store point dataset and breaklines, as well as to define how many LODs the TIN will store.

We propose a single structure to store multiscale TIN. The data structure needs to store only the point set with its two coordinates ( $X$ ,  $Y$ ), height value, and significance degree, as shown in chapter four. These data are stored in a database after building full TIN and calculating the vertexes significance degree. The Delaunay triangulation algorithm insures that in full model the vertexes will always have the same topological relationships. According to the results in chapter 4, the vertexes ranking method enables morphological features to be conserved in multiscale models.

As advantages of our method we highlight:

- a) It becomes available for integration with other tools or applications such as hazard forecast with its implementation in TerraLib;
- b) It stores only points therefore, less space is needed in DBMS;

---

<sup>2</sup> <http://www.dpi.inpe.br/terralib/>

- c) It allows building TIN with many LODs, since the number of vertexes is defined by the user;
- d) It is simpler to store point dataset as it does not need any special data type, and can be used in any DBMS.

In the next chapter, we show the achieved results and an assessment of the method. We implemented the proposed method and tested it with two different datasets and compared it with other method.

## 4 RESULTS

We use two datasets to test our method (Figure 4.1). One dataset with 35166 sample points represents the region of Mount Marcy and the other dataset with 15837 sample points represents the topography of the city of Brasilia. The difference between these datasets is that the Mount Marcy data have an almost regular spatial distribution, while Brasilia data are comprised by survey data and points from contour lines. Brasilia dataset has an irregular spatial distribution.

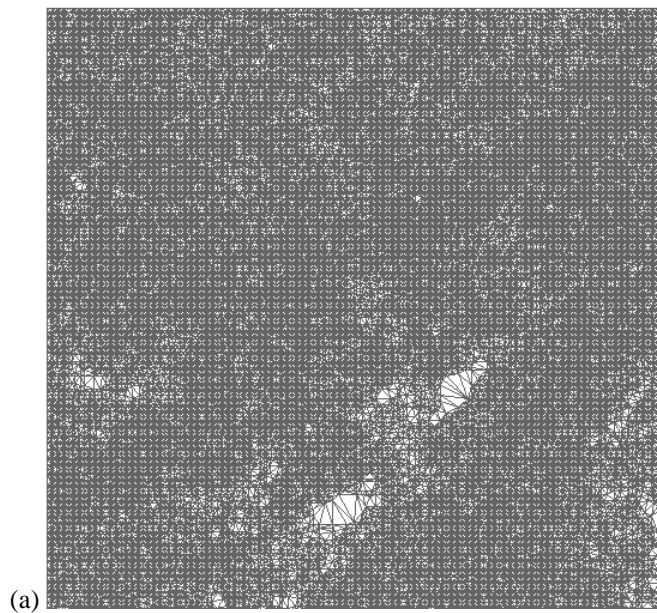

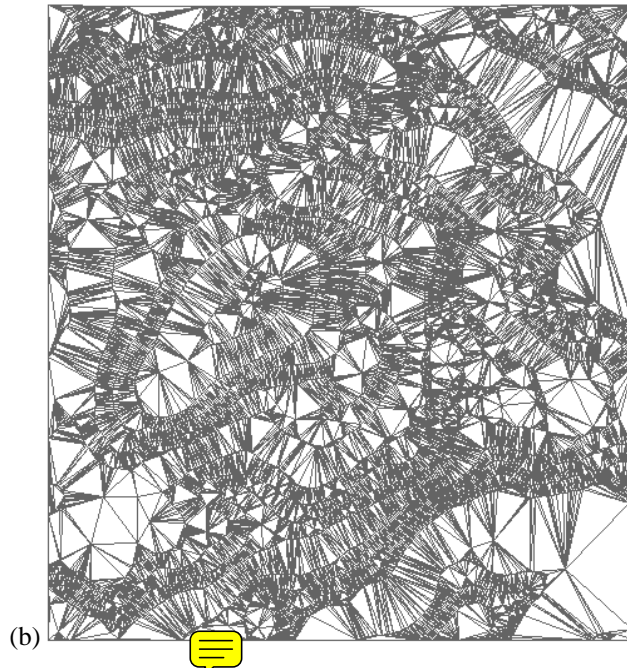

Figure 4.1 – ~~A TIN of (a) Mount Marcy dataset and (b) Brasilia dataset~~

Aiming to evaluate the quality of the proposed method, we compare the multiscale TIN models with models created by the Multi-Tessellation library. The Multi-Tessellation library implements the Multi-Triangulation (MT) model. MT is a model for handling multiscale triangular mesh in varying levels of detail. De Floriani (1997) and Puppo (1998) make a formal and detailed presentation of the MT model, and its concepts are implemented in the Multi-Tessellation library.

The Multi-Tessellation library (MAGILLO, 2005) was developed by DISI<sup>3</sup>. This is an open-source library developed in ANSI C++ language and released under the General Public License (GNU). Multi-Tessellation is a package for the representation and manipulation of spatial objects in  $N$  dimensions and multiple resolutions, whose data manipulation occurs in the main memory.

Basically the Multi-Tessellation library performs two actions:

---

<sup>3</sup> Dipartimento di Informatica e Scienze Dell'informazione - University of Genoa, Italy

- a) Uses the process of creating a triangular mesh, which describes a spatial phenomenon, to build a multiscale representation of the mesh. The representation is defined by a Directed Acyclic Graph (DAG).
- b) Recovers mesh at different levels of detail from MT.

With the Multi-Tessellation library the MT-Delaunay Program<sup>4</sup> is available. MT-Delaunay Program allows the generation of MTs terrains, which is based on the Delaunay triangulation. One of the program basic functionalities is construction of a Delaunay triangulation starting from the set of points through iterative vertex insertion, and production of an MT. We use only vertical error as threshold to build multiscale TIN with different levels of detail, and to make a comparison with the meshes generated by the proposed method.

We ran our algorithm to calculate significance degree of vertexes from full TIN. Then, we built reduced TIN with a defined number of vertexes. The selected vertexes are the N vertexes with highest significance degree, lets N be the number of TIN vertexes.

Figure 4.2 shows a comparison between of results for multiscale TIN with different number of vertexes. We built TIN with 80% (27355 vertexes), 50% (19814 vertexes) and 20% (7424 vertexes) of vertexes used in full TIN from Mount Marcy dataset and multiscale TIN built from MT-Denaulay.

---

<sup>4</sup> <http://www.disi.unige.it/person/MagilloP/MT/mtdelaunay.html>



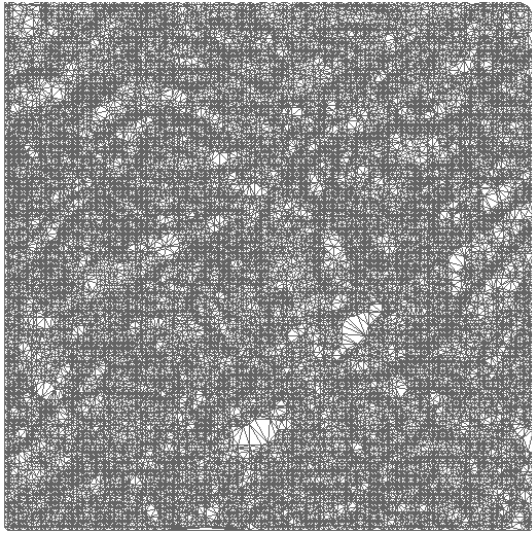

(a)

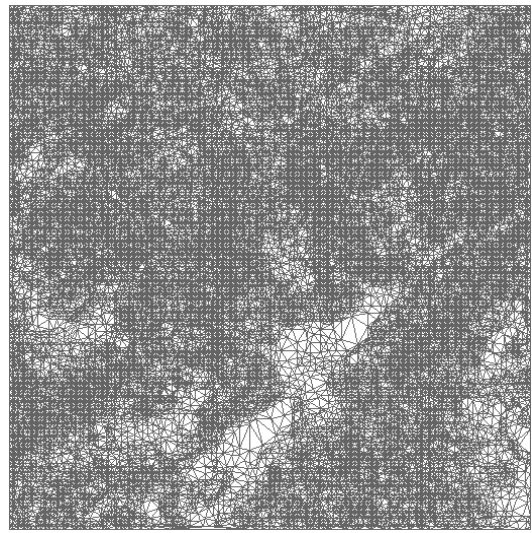

(b)

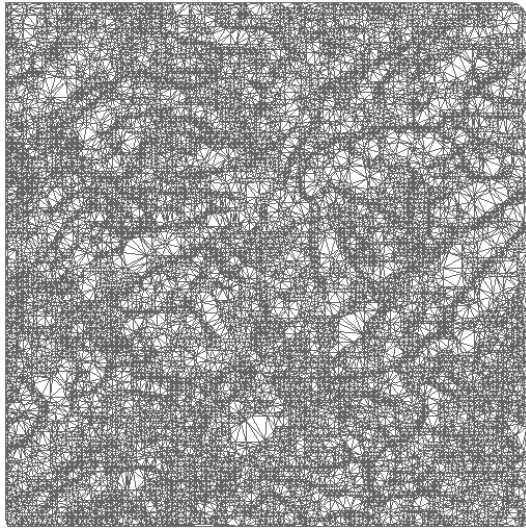

(c)

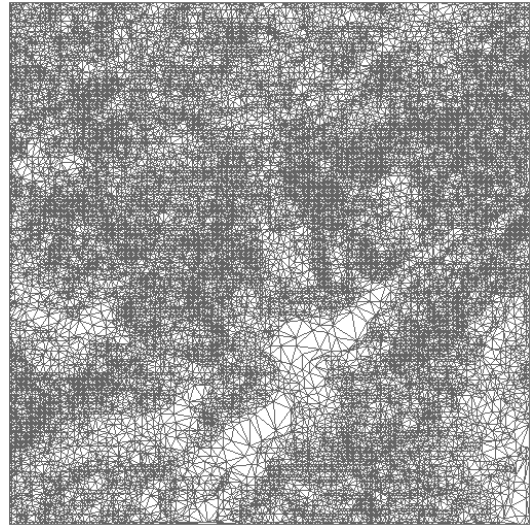

(d)





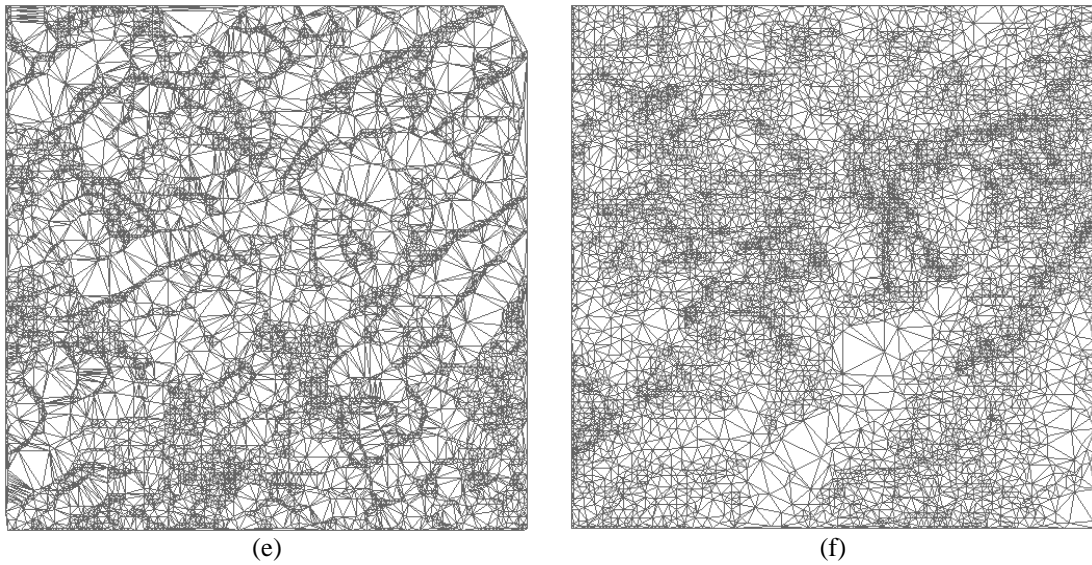
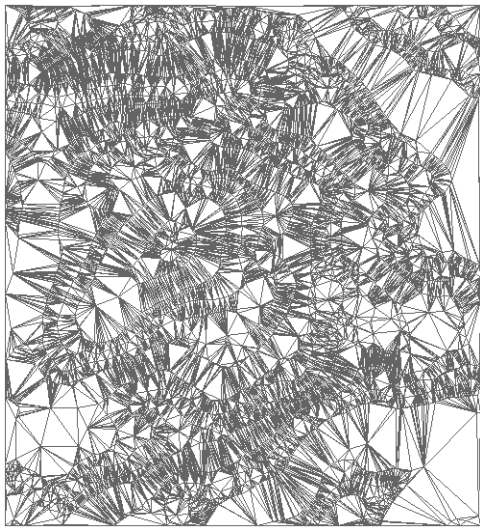

Figure 4.2 – Comparison of Multiscale TIN from Mount Marcy dataset with 80% (a) our method (b) MT, 50% (c) our method (d) MT, and 20% (e) our method (f) MT.

In Figure 4.2, we see that our method preserves some areas of terrain, with more vertexes, as they are important to preserve relevant features of the terrain. In TIN from MT, since only the vertical error factor is used, the simplification meshes often scatter uniformly, and so, important morphological features on the terrain cannot be kept if many vertexes have been removed.

The comparison among the results from Brasilia datasets is in Figure 4.3. We built TIN with 60% (9216 vertexes), 40% (6363 vertexes) and 20% (3107 vertexes) of vertexes used in full TIN from Brasilia dataset. The query from MT does not establish how many vertexes one needs in order to build multiscale TIN, thus, we built TIN with the closest possible number of vertexes to MT query. The results follow the same trend as Mount Marcy dataset. In other words, TIN from MT has uniform distribution.



(a)

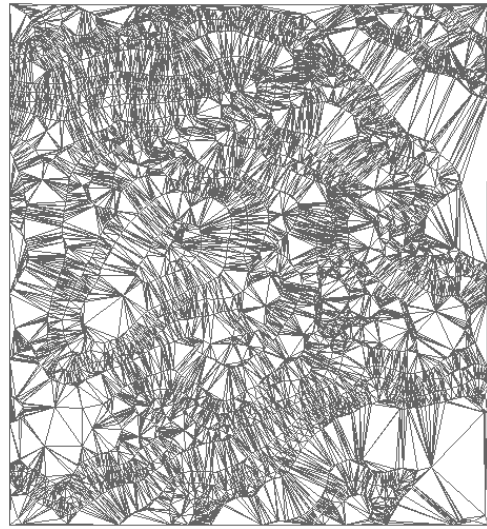

(b)

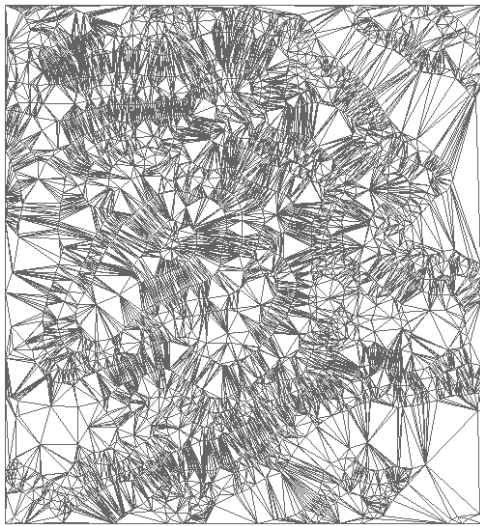

(c)

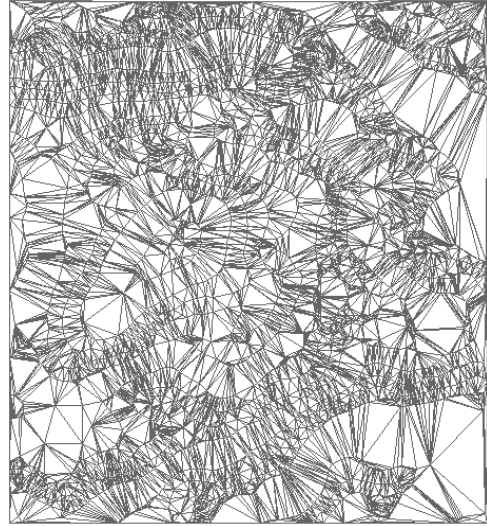

(d)

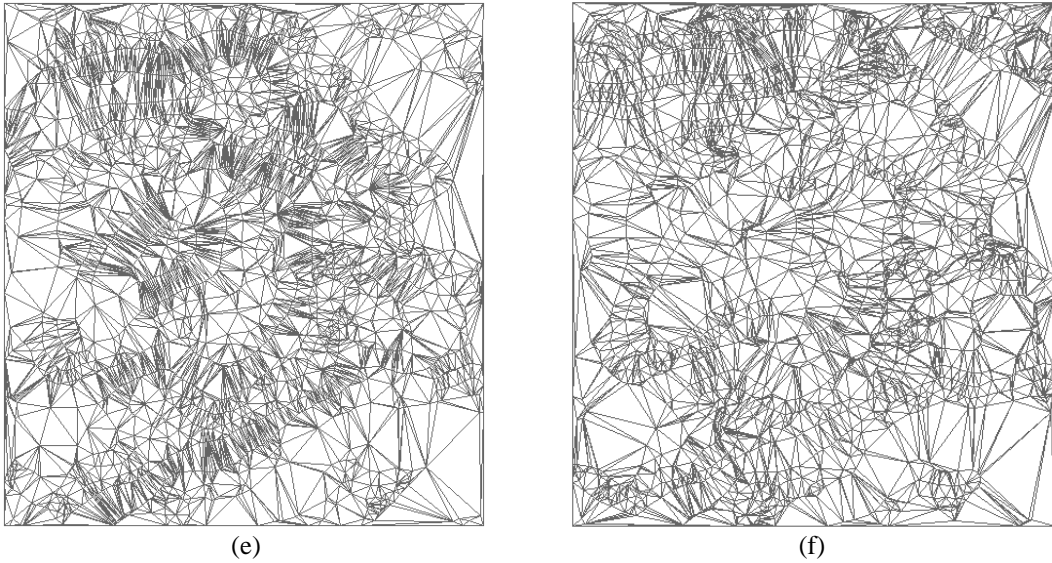

Figure 4.3 – Comparison of Multiscale TIN from Brasilia dataset with 60% (a) our method (b) MT, 40% (c) our method (d) MT, and 20% (e) our method (f) MT.

#### 4.1. Numerical evaluation

To measure the result of our method, we created 3000 random points, spatially scattered, called control points, to assess the characteristics of slope and aspect of models. For each control point we calculated the slope and aspect degree. Then, we calculated the mean true error (MTE) over the 3000 control points. The MTE (4.1) is given by:

$$MTE = \frac{1}{n} \sum_{i=1}^n (f_i - y_i) \quad (4.1)$$

Where:

$f_i$  is the calculated value from reduced TIN;

$y_i$  is the value from full TIN; and

$n$  is the number of control points.

The MTE shows the systematic error or if data are tendentious, that is, the MTE points to the offset by positive and negative values. Afterwards, we calculated

the root mean square error (RMSE) over control points to measure the models precision. The RMSE (4.2) is given by:

$$RMSE = \sqrt{\frac{1}{n} \sum_{i=1}^n (f_i - y_i)^2} \quad (4.2)$$

Where:

$f_i$  is the calculated value from reduced TIN;

$y_i$  is the value from full TIN; and

$n$  is the number of control points.

To examine the differences between the two models, we built 7 reduced TIN with 80%, 70%, 50%, 40%, 30%, 20% e 10% of vertexes from full TIN. We calculated MTE and RMSE from reduced TIN of both our method and MT. Figure 4.4 shows a comparison between calculated values for slope degree. The values of MTE and RMSE from MT we called MTE MT slope and RMSE MT slope respectively.

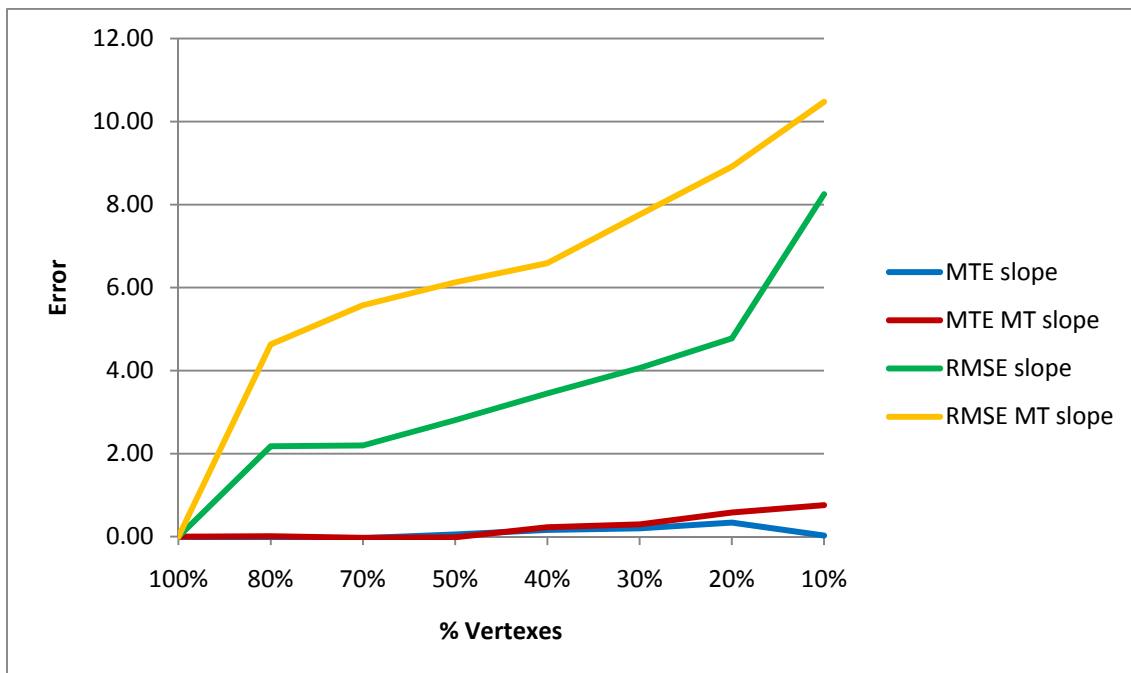

Figure 4.4 – MTE and RMSE slope values for TIN from Mount Marcy with different number of vertexes.

The results show that the MTE values from our method have lower variation than those of MTE MT, while the MTE MT values have a tendency to increase when decreasing the number of vertexes. This shows that MT has a tendency to produce models with higher positive slope. Our method presented RMSE lower than that of MT model for all TIN.

In Figure 4.5, the results show that our method achieves better marks than those of MT, with MTE values lower variation than MTE MT and RMSE lower than MT. This reinforces that our method achieves better approximation of the characteristic of slope and aspect in the reduced TIN than that of the MT model.

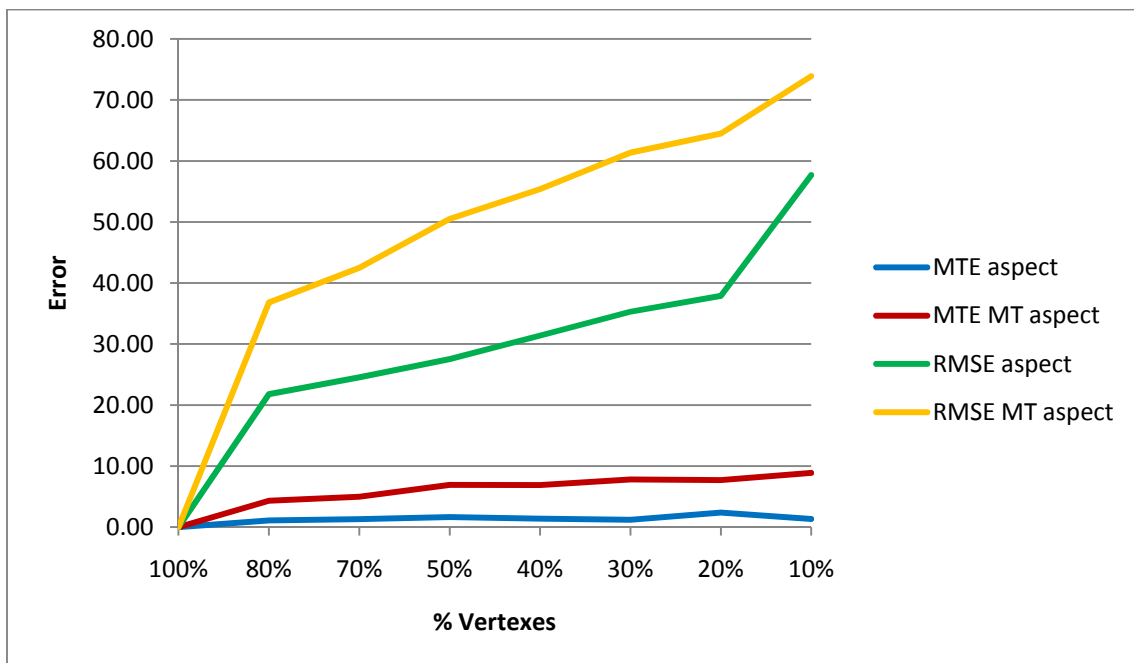

Figure 4.5 – MTE and RMSE aspect values for TIN from Mount Marcy with different number of vertexes.

Figure 4.6 shows the results of MTE and RMSE to slope degree for Brasilia dataset. The results show that both MTE and RMSE from our method are slightly higher than MT values for TIN with 60%, 50% and 40% of vertexes. However, our method presents lower values to MTE and RMSE when the

number of vertexes decreases to 30%, 20% and 10%. Perhaps this happens due to the shape of triangles mesh. The triangles of TIN from Brasilia dataset are longer, and the vertexes have an irregular spatial distribution. This is because most of vertexes are from contour lines.

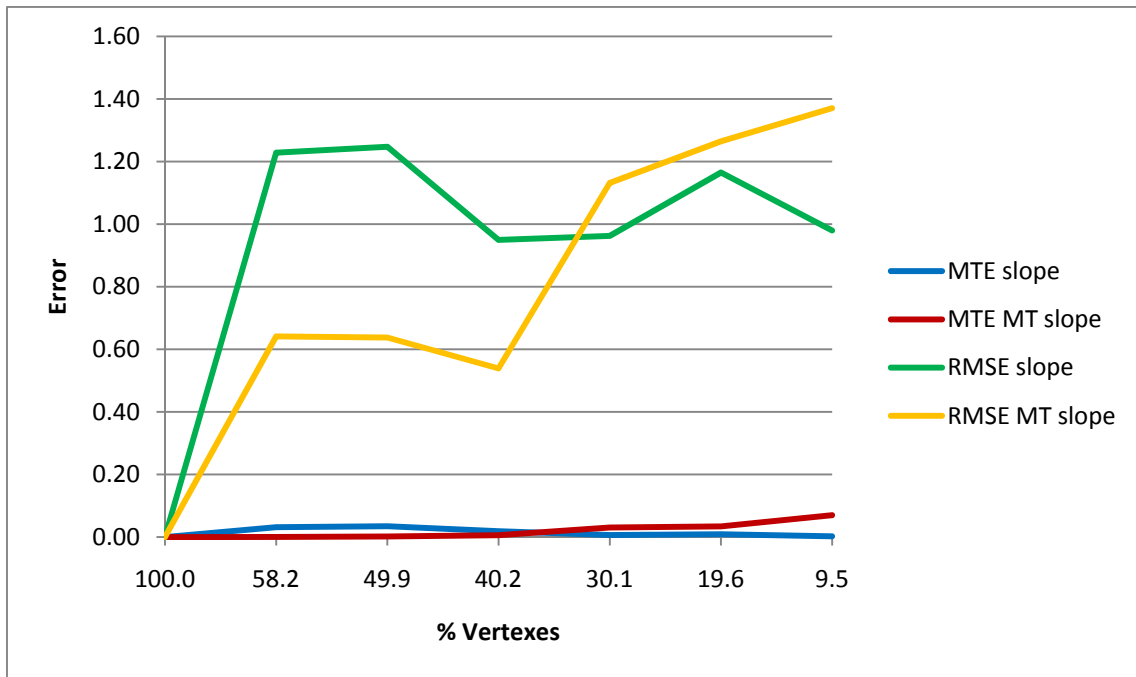

Figure 4.6 – MTE and RMSE slope values for TIN from Brasilia with different number of vertexes.

The evaluation of Brasilia dataset aspect degree is in Figure 4.7. The results show a tendency of increasing both MTE and RMSE of our method with a decrease in the number of vertexes, but they are lower than MT values.

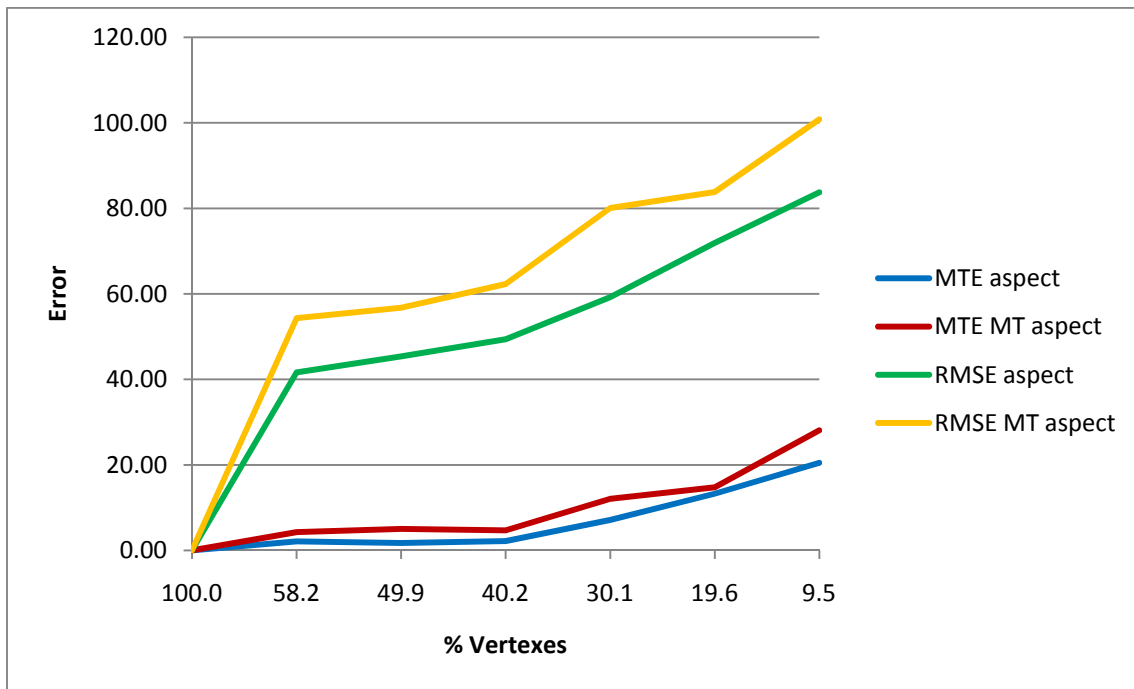

Figure 4.7 – MTE and RMSE aspect values for TIN from Brasilia with different number of vertexes.

In summary, according to the results shown, our method can build multiscale TIN that preserves important characteristics of slope and aspect.





## 5 CONCLUSION AND FUTURE WORK

In this thesis, we study the building of multiscale TIN and its storage in spatial database. Based on the problem analysis of existing multiscale TIN building methods, a novel mesh refinement method, the method of ranking sample points, is proposed to preserve terrain morphological features. This is followed by the introduction of new data structure to store multiscale TIN, which is the simplest way of storing TIN.

### 5.1. Main Contributions

The following is a summary of the main contributions of this thesis:

1. A method to build multiscale TIN, based on vertex significance degree is proposed. This method uses slope and aspect degree, as a criterion to simplify the TIN instead of using vertical error. Therefore, the built models maintain better slope and aspect measurements than those based on vertical error methods as shown in the experimental results.
2. A new data structure designed for multiscale TIN storage, which stores the sorted vertexes of triangulation. The table that stores the vertexes has the vertex coordinates ( $X, Y$ ), height value, and vertex significance degree.
3. The retrieval of TIN from spatial database, with many LODs is possible, and with the number of vertexes defined by the user.
4. As a result of implementation in TerraLib, the method becomes available for integration with other tools or applications such as hazard forecast.

### 5.2. Future Work

Storing multiscale TIN is fundamental in many terrain applications, most of which can benefit from the results in this thesis. However, we consider that these results can be further improved and optimization is possible for specific

types of applications. We expect that the work in this thesis can be extended in the following directions:

1. Further developments of the work consist in improving the method of ranking sample points. Maybe, improving the computation of vertexes significance degree, using different weights to calculate the significance degree.
2. Carry out tests in order to assess retrieval performance or integration with other retrieval methods for visualization.

## REFERENCES

ANIL, M.; PAT, M.; J; RG, R.; DIGER, S., 1997, ~~Progressive TINs: algorithms and applications~~, Proceedings of the 5th ACM international workshop on Advances in geographic information systems, Las Vegas, Nevada, United States, ACM.

AURENHAMMER, F. Voronoi diagrams - a survey of a fundamental geometric data structure. **ACM Computer Surveys**, v. 23, n. 3, p. 345-405, 1991.

BERG, M. D.; KEIL, M. V.; HERMARS, M.; SCHWARZKOPF, O. **Computational Geometry: Algorithms and Applications**. 2nd ed. New York: Springer-Verlag, 2000. 367 p.

BJORKE, J. T.; NILSEN, S. Wavelets applied to simplification of digital terrain models. **International Journal of Geographical Information Science**, v. 17, n. 7, p. 601-621, 2003.

BONIN, O.; ROUSSEAU, F. Digital terrain model computation from contour lines: How to derive quality information from artifact analysis. **Geoinformatica**, v. 9, n. 3, p. 253-268, 2005.

BOWYER, A. Computing Dirichlet tessellations. **The Computer Journal**, v. 24, n. 2 p. 162-166, 1981.

CÂMARA, G.; SOUZA, R.; PEDROSA, B.; VINHAS, L.; MONTEIRO, A. M.; PAIVA, J.; CARVALHO, M. T.; GATTASS, M. TerraLib: Technology in Support of GIS Innovation. In: II Brazilian Symposium on Geoinformatics, GeoInfo2000, São Paulo. **Proceedings**. 2000.

CARNEIRO, E. L. N. C.; CÂMARA, G.; NAMIKAWA, L. M., 2008, **Estudo sobre armazenamento de modelagem digital de terreno em banco de dados geográficos**, VIII Workshop do Curso de Computação Aplicada – CAP, São José dos Campos-SP, INPE.

CARRARA, A.; BITELLI, G.; CARLA, R. Comparison of techniques for generating digital terrain models from contour lines. **International Journal of Geographical Information Science**, v. 11, n. 5, p. 451-473, 1997.

CHAU, K. T.; TANG, Y. F.; WONG, R. H. C. GIS based rockfall hazard map for Hong Kong. **International Journal of Rock Mechanics and Mining Sciences**, v. 41, n. 1, p. 846-851, 2004.

CHENG, I.; BASU, A. Perceptually optimized 3-D transmission over wireless networks. **IEEE Transactions on Multimedia**, v. 9, n. 2, p. 286–396, 2007.

CIGNONI, P.; PUPPO, E.; SCOPIGNO, R. Representation and visualization of terrain surfaces at variable resolution. **The Visual Computer**, v. 13, n. 5, p. 199-217, 1997.

DE FLORIANI, L.; MAGILLO, P.; PUPPO, E. Efficient implementation of multi-triangulations. In: Visualization '98, Research Triangle Park, NC, USA. **Proceedings**. IEEE, 1998. p. 43-50.

\_\_\_\_. VARIANT: A System for Terrain Modeling at Variable Resolution. **Geoinformatica**, v. 4, n. 3, p. 287-315, 2000.

DE FLORIANI, L.; PUPPO, E.; MAGILLO, P. A Formal Approach to Multiresolution Hypersurface Modeling. In: STRABER, W.; KLEIN, R.; RAU, R. (Ed.). **Geometric Modeling: Theory and Practice**. Springer-Verlag, 1997.

DIXON, L. F. J.; R. BARKER, M. B., P. FARRES, J. HOOKE, R. INKPEN, A. MEREL, D. PAYNE, A. SHELFORD. Analytical Photogrammetry for Geomorphological Research. In: LANE, S. N.; RICHARDS, K. S.; CHANDLER, J. H. (Ed.). **Landform Monitoring, Modelling, and Analysis**. Chichester, England: John Wiley and Sons Ltd., 1998.

EL-SHEIMY, N.; VALEO, C.; HABIB, A. **Digital Terrain Modeling: Acquisition, Manipulation And Applications**. ed. Norwood, MA: Artech House Publishers, 2005. 270 p. ISBN 1580539211.

ESRI. **ArcGIS 10 Desktop Help**. Redlands, CA, 2010. Disponível em: <http://help.arcgis.com/en/arcgisdesktop/10.0/help/>. Acesso em: 12/10/2010.

FRANKLIN, W. R.; METIN, I.; ZHONGYI, X.; DANIEL, M. T.; BARBARA, C.; MARCUS, V. A. A., 2007, **Smugglers and border guards: the GeoStar project at RPI**, Proceedings of the 15th annual ACM international symposium on Advances in geographic information systems, Seattle, Washington, ACM.

GARLAND, M. Multiresolution Modeling: Survey & Future Opportunities. In: EUROGRAPHICS '99 - State of the Art Report (STAR), Aire-la-Ville (CH). **Proceedings**. 1999. p. 111-131.

GARLAND, M.; HECKBERT, P. S. Surface simplification using quadric error metrics. In: SIGGRAPH '97, **Proceedings**. 1997. p. 209-216.

GRAY, J. T.; LINSEN, L.; HAMANN, B.; JOY, K. I. Adaptive multi-valued volume data visualization using data-dependent error metrics. In: IEEE Conference on Visualization, **Proceedings**. 2003.

GUIBAS, L.; STOLFI, J. Primitives for the Manipulation of General Subdivisions and the Computation of Voronoi Diagrams. **ACM Transactions on Graphics**, v. 4, n. 2, p. 74-123, 1985.

HARDING, D. J.; BUFTON, J. L.; FRAWLEY, J. J. Satellite Laser Altimetry of Terrestrial Topography - Vertical Accuracy as a Function of Surface Slope, Roughness, and Cloud Cover. **IEEE Transactions on Geoscience and Remote Sensing**, v. 32, n. 2, p. 329-339, 1994.

HOBBS, J.; MOORE, R. C. **Formal Theories of the Commonsense World**. ed. Ablex, 1985.

ILFICK, M. H. Contouring by Use of a Triangular Mesh. **Cartographic Journal**, v., n., p. 24-28, 1979.

KIDNER, D. B.; WARE, J. M.; SPARKES, A. J.; JONES, C. B. Multiscale Terrain and Topographic Modelling with the Implicit TIN. **Transactions in GIS**, v. 4, n. 4, p. 379-408, 2000.

KUMLER, M. P. An Intensive Comparison of Triangulated Irregular Networks (TINs) and Digital Elevation Models (DEMs). **Cartographica**, v. 31, n. 2, p. 1-99, 1994.

LARSEN, B. D.; CHRISTENSEN, N. J. Real-time Terrain Rendering using Smooth Hardware Optimized Level of Detail. **Journal of WSCG**, v. 11, n. 1, p. 8, 2003.

LI, Y.; ZHU, Q. A New Mesh Simplification Algorithm Based on Quadric Error Metrics. In: International Conference on Advanced Computer Theory and Engineering, **Proceedings**. IEEE Computer Society, 2008. p. 528-532.

LI, Z.; ZHU, Q.; GOLD, C. **Digital Terrain Modeling: Principles and Methodology**. ed. Boca Raton, Florida: CRC Press, 2005. 323 p. ISBN 0415324629.

LINDSTROM, P.; PASCUCI, V. Terrain simplification simplified: a general framework for view-dependent out-of-core visualization. **IEEE Transactions on Visualization and Computer Graphics**, v. 8, n., p. 239-254, 2002.

LINSEN, L.; HAMANN, B.; JOY, K. I. Wavelets for Adaptively Refined  $3\sqrt{2}$ -Subdivision Meshes. **International Journal of Computers & Applications**, v. 29, n. 3, p. 223-231, 2007.

LITTLE, J. J.; SHI, P. Ordering points for incremental TIN construction from DEMs. **Geoinformatica**, v. 7, n. 1, p. 33-53, 2003.

MAGILLO, P. **The MT (Multi-Tesselation) Library**. Genova, Italia, 2005. Disponível em: [www.disi.unige.it/person/MagilloP/MT/](http://www.disi.unige.it/person/MagilloP/MT/). Acesso em: junho.

MARCELINO, E. V., 2007, **Desastres naturais e geotecnologias: Conceitos Básicos**, Santa Maria - Brasil, CRS/INPE.

MARK, D. M. The history of geographic information systems: invention and re-invention of triangulated irregular networks (TINs). In: GIS/LIS'97, October 28-30, 1997. Cincinnati, Ohio. **Proceedings**. American Society for Photogrammetry and Remote Sensing, 1997. p. 284-289.

MAUNE, D. F. (Ed.). **Digital Elevation Model Technologies and Applications : The DEM Users Manual**. Bethesda, Md.: American Society for Photogrammetry and Remote Sensing, 2001. 539 p.

MURRAY, C. **Oracle Spatial Developers Guide 11g Release 1 (11.1)**. Redwood City: Oracle Corporation, 2009. 870 p.

NAMIKAWA, L. M. **Um Método de Ajuste de Superfície Para Grades Triangulares Considerando Linhas Características - A TRIANGULAR SURFACE FITTING METHOD USING BREAKLINES**. 1995. 136 p. Master in Sciences (Computação Aplicada) – INPE - Instituto Nacional de Pesquisas Espaciais, São José dos Campos, Brazil. 1995.

NAMIKAWA, L. M.; FELGUEIRAS, C. A.; MURA, J. C.; ROSIM, S.; LOPES, E. S. S. **Modelagem numérica de terreno e aplicações**. ed. São José dos Campos, SP, Brazil: INPE, 2003. 158 p.

OGC. **OpenGIS Simple Features Specification for SQL**. Boston: Open GIS Consortium, 1998a.

\_\_\_\_\_. **The OpenGIS Specification Model: The Coverage Type and Its Subtypes**. Wayland, MA: Open Geospatial Consortium, 1998b. (OpenGIS Project Document Number 98-106R2).

\_\_\_\_\_. **OpenGIS Implementation Specification : Grid Coverage**. Boston: Open Geospatial Consortium, 2001. (OGC Document Number 01-004).

OKABE, A.; BOOTS, B.; SUGIHARA, K.; CHIU, S. N.; KENDALL, D. G. **Spatial tessellations: concepts and applications of Voronoi diagrams**. 2nd. ed., 2000.

PREPARATA, F.; SHAMOS, M. **Computational Geometry**. ed. New York: Springer-Verlag, 1985. 398 p.

PUPPO, E. Variable Resolution Triangulations. **Computational Geometry: Theory and Applications**, v. 11, n. 3-4, p. 219-238, 1998.

RAMSEY, P. **PostGIS Manual**. Victoria, Canada: 2007. Disponível em: <http://postgis.refractory.net/docs/postgis.pdf>. Acesso em: 10/05/2007.

RENNÓ, C. D. Eliminação de áreas planas e extração automática de linhas de drenagem em modelos digitais de elevação representados por grades triangulares. In: XII Simpósio Brasileiro de Sensoriamento Remoto, Goiânia, Brasil. **Proceedings**. 2005. p. 2543-2550.

REZENDE, P. J. D.; STOLFI, J. Fundamentos da Geometria Computacional. In: IX Escola de Computação, Recife, Brasil. **Proceedings**. 1994.

RIBELLES, J.; LÓPEZ, A.; BELMONTE, O.; REMOLAR, I.; CHOVER, M. Multiresolution modeling of arbitrary polygonal surfaces: a characterization. **Computers & Graphics**, v. 26, n. 3, p. 449-462, 2002.

SANYAL, J.; LU, X. X. GIS-based flood hazard mapping at different administrative scales: A case study in Gangetic West Bengal, India. **Singapore Journal of Tropical Geography**, v. 27, n. 2, p. 207-220, 2006.

SCHROEDER, W. J.; ZARGE, J. A.; LORENSEN, W. E. Decimation of triangle meshes. **Computer Graphics**, v. 26, n. 2, p. 65-70, 1992.

SIBSON, R. Locally Equiangular Triangulations. **The Computer Journal**, v. 21, n., p. 243-245, 1978.

STOTER, J.; VAN OOSTEROM, P. Incorporating 3D geo-objects into a 2D geo-DBMS. In: ACSM/ASPRS, Washington DC, USA. **Proceedings**. 2002. p. 19-26.

WATSON, D. F. Computing the n-dimensional Delaunay tessellation with application to Voronoi polytopes. **The Computer Journal**, v. 24, n. 2 p. 167-172, 1981.

XU, K.; ZHOU, X.; LIN, X.; SHEN, H. T.; DENG, K. A multiresolution terrain model for efficient visualization query processing. **IEEE Transactions on Knowledge and Data Engineering**, v. 18, n. 10, p. 1382-1396, 2006.

YANG, B.; PURVES, R. S.; WEIBEL, R. Variable-resolution Compression of Vector Data. **Geoinformatica**, v. 12, n., p. 357-376, 2008.

YANG, B.; SHI, W.; LI, Q. A Dynamic Method for Generating Multi-Resolution TIN Models. **Photogrammetric Engineering and Remote Sensing**, v. 71, n. 8, p. 917-926, 2005a.

\_\_\_\_\_. An integrated TIN and Grid method for constructing multi-resolution digital terrain models. **International Journal of Geographical Information Science**, v. 19, n. 10, p. 1019-1038, 2005b.

YANG, B. S.; LI, Q. Q.; SHI, W. Z. Constructing multi-resolution triangulated irregular network model for visualization. **Computers and Geosciences**, v. 31, n. 1, p. 77-86, 2005c.

ZLATANOVA, S., 2002, **Advances in 3D GIS**, Disegno Digitale e Design, p. 24-29.

\_\_\_\_. **3D geometries in spatial DBMS**. Delft University of Technology, 2006.

ZLATANOVA, S.; RAHMAN, A. A.; PILOUK, M. Trends in 3D GIS Development. **Journal of Geospatial Engineering**, v. 4, n. 2, p. 71-80, 2002.