

SYSTEMS CONCURRENT ENGINEERING FOR THE CONCEPTION OF AN ATTITUDE AND ORBIT CONTROL SYSTEM

Ariana Cristina Caetano de Souza¹, Lauro Paulo da Silva Neto²,
Leonardo Leite Oliva³ e Geilson Loureiro⁴

National Institute for Space Research - INPE,
São José dos Campos, SP, Brazil

¹ ariana_caetano@yahoo.com.br, ² silvaneto007@yahoo.com.br,
³ leonardoleite.oliva@gmail.com e ⁴ geilson@lit.inpe.br

Abstract: *This paper presents a systems concurrent engineering approach for the conception of an Attitude and Orbit Control System for a Satellite (AOCS). Systems Engineering uses a multidisciplinary approach in order to better understand complex systems and its processes, its products and its organization. The main goal is to satisfy all stakeholders involved in the product and its processes. In this paper several concepts of Systems Engineering, as well as its methodology, were applied in the main processes of the life cycle of an AOCS of an artificial satellite, in order to give a better understanding of the development of this kind of product, from requirements analysis to system operation.*

Keywords: *Systems concurrent engineering, systems engineering, stakeholders, attitude and orbit control system*

1 Introduction

Concurrent Engineering is a systematic approach to the concurrent and integrated development of the product and its related processes, including support and manufacture. This approach is essential to bring the requirements from all people involved in the product life cycle process implementation to the early stages of product development. All measurable elements in the product life cycle – from the conception to the disposal – such as costs, deadlines, quality and requirements, are essential in this study. Concurrent Engineering requires an environment of development, with interrelationship between several types of professionals that are important for the product life cycle processes. To accomplish this goal it is essential to use diagrams and a methodology that allows all people involved in the project to understand each other. The philosophy is to build a map of the product life cycle so that everyone has a general view and understands his role.

The development of complex systems, such as those found in space industry, usually requires effort of several technical areas such as computer, electrical, mechanic, control, thermal and materials engineering, physics, chemistry, etc. During a satellite development phase, specific technical teams are called in order to build a successful product. Those teams usually don't communicate with each other, ignoring important information produced by their work neighbors, which leads to a rise in the cost of the project during the development phase, the assembly phase, the integration and testing phase and the operational phase. This can lead to an early and unexpected failure. Therefore, space systems need to use methods that are capable of giving a holistic view of the scope of development. This paper was made in order to give such a vision applying concepts of Systems Engineering, where the product and the life cycle process organizations are analyzed as a part of the same whole.

2 The AOCS

The mission of the AOCS is to point and maintain satellite pointing with previously established precision, regarding its mission within all its life cycle. To achieve this objective, it is essential to have a broad view of the system life cycle, with all its relationships with the ground segment, the space segment, the launcher and the user. Therefore, several relations between development environments were created. Those relations considered human elements or entities (technicians, engineers, users, administrators, government, companies, etc), physical effects (radiation, particle collision, electric current, etc) and information (data, knowledge, projects, etc). For the AOCS there were identified the following processes during the system life cycle: development, production, integration and tests, launch, operation and toss (figure 1).

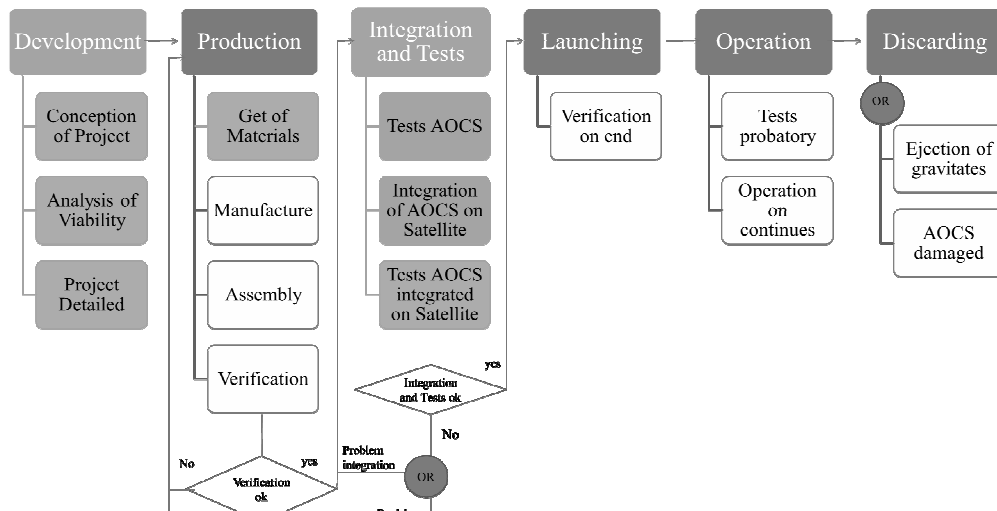

Figure 1. Processes in the life cycle of the AOCS.

The Development Process involves the project conception, where the first ideas are given and gathered together in order to meet the basic needs (requirements) established by the stakeholders. These ideas will pass through several reviews, whose objective is to improve the system design before any material is acquired. There is also the Viability Analysis, which is responsible for studying the viability of the whole process taking into consideration the chronogram and the financial availability for the project.

In the Production Process the material acquisition takes place. These materials must be qualified, attending all norms in order to guarantee a safe and satisfactory operation for the product during launch and in space environment. In the fabrication all materials acquired become modules of electronic circuits, mechanical devices, structures, thermal ducts and so on. The assembly is the integration of those systems, linking the different subsystems so that they can operate as a whole (for example, the electronic circuits are placed inside a structure that has a cooling system to maintain certain temperature so that the circuits operate without loss of energy). After that the verification begins. It consists in several tests that permit identify if and how the system works, using simulation to measure performance. When the system meets all norms in this phase, the next step takes place.

The Integration and Tests phase is responsible for tests of static and dynamic nature of the subsystem AOCS individually, as well as those same tests with the AOCS integrated to the entire system (satellite). Those tests are four: thermal, vibration, acoustic and electromagnetic compatibility (EMC). After the system proves that it attends all requirements of those tests it is ready for launch. In this phase, another integration and test take place. This will guarantee that the AOCS and the satellite are integrated to the launcher, and therefore are ready for launch and operation.

Before the full operation of the system there are some probatory tests that must take place – with the satellite already in orbit. Those tests are conducted by the Track and Control Center whose goal is to check the operation of all subsystems that compose the satellite. After this phase, the system enters in a continuous operation phase, in which each subsystem begins to perform its specific task. The AOCS uses the data collected by its sensors and those given by the on board computer to adjust the vehicle attitude and orbit so that the vehicle is able to perform its main task.

The final phase (orbit ejection) occurs either if the subsystem (AOCS) is damaged or if another important subsystem suffers the same. In a more optimistic case, this phase will take place at the end of the mission, when the satellite has already fulfilled all expectations.

3 Method

The analysis method was separated in seven parts as follows:

1. Process Structure;
2. Stakeholder Analysis;
3. Context and Architecture Diagrams;
4. Functional structure (Data Flow Diagrams (DFD)) and behaviour (State Transition Diagrams);
5. Hazard Analysis;
6. Architecture Flow and Interconexion Diagrams ;
7. Allocation matrix.

Each part is responsible for a specific view of the product and its life cycle processes.

The activity diagram (1), also called IDEF0, is a function modelling methodology for describing manufacturing functions, and shows all the system life cycle in study with rectangles (processes) that are connected by arrows (flows of material, energy and information).

The stakeholder analysis (2) was divided in four parts: product stakeholders (operation process / production process); and organization stakeholders (development process / integration and tests process). Due to the different emphasis of each part, the views of the same stakeholder may be different (or not).

The context and architecture diagrams (3) show the exchange of material, energy and information between the elements of the environment and the objects in the product and life cycle process organizations. At this stage some circumstances for the environments elements are identified.

The DFD and transition diagrams (4) are tools that enable a better understanding of the data flow in the system. The DFD shows the messages sent and received by each physical component, creating an information net that links all subsystems, while the transition diagrams shows all the possible states of the system (rectangles) and the events responsible by its changes (arrows).

There is a hazard analysis (5), that is a process used to assess risk. The result of such analysis is the identification of unacceptable risks and the selection of means for mitigating them.

Other diagrams include those of interconnection and flow (6), which represent, respectively, the flows of material, energy and information and the physical connections between the inner components of a product or life cycle process organization.

Finally, there is the allocation matrix (7), the final stage of application of systems concurrent engineering. This matrix relates the functions and all parts responsible by them.

4 Results

The IDEF0 diagram was constructed considering all life cycle process of the AOCS, since the initial sketches. Figure 2 shows the flow of the product AOCS.

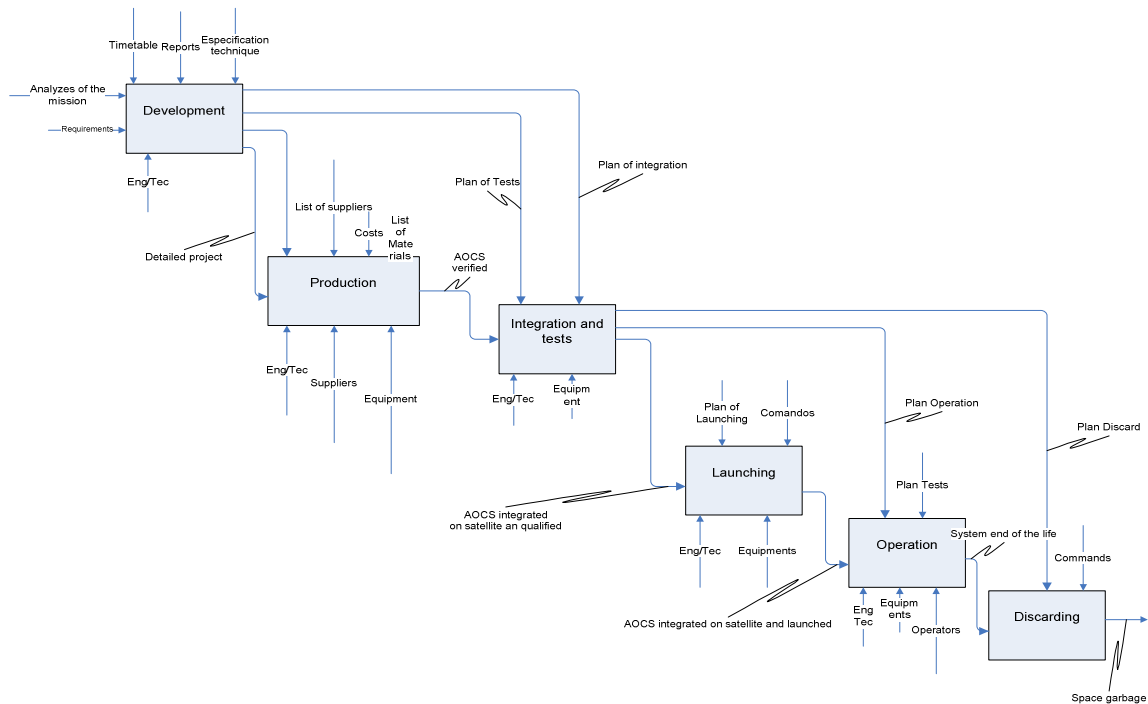

Figure 2. IDEF0 Diagram of the AOCS.

As it can be seen, the flows that enter in the upper side of the rectangles are controls (information) that allow coordinate the process. They work as a guide element. In the development phase, they are reports, chronograms and technical specifications.

The left side entries are inputs and the right ones – that go out – are outputs. They are used to show the materialization of the product, specifying what will be the basic material – the product in a stage of development – to start the process, and how the product or information (output) comes out after the process has been executed.

All flows that come from below are necessary in most processes. They represent the entry of energy, basic material and human resources in the process.

Stakeholder analysis took into consideration four points of view (see Method section). Each one of them has a particular look at the process/product. Figures 3 to 6 show the stakeholders in each of these cases.

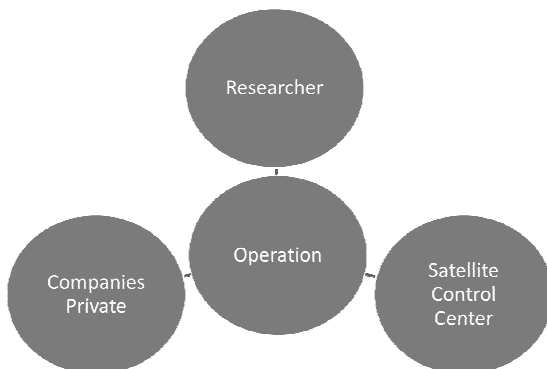

Figure 3. Stakeholders of Product: Operation Process

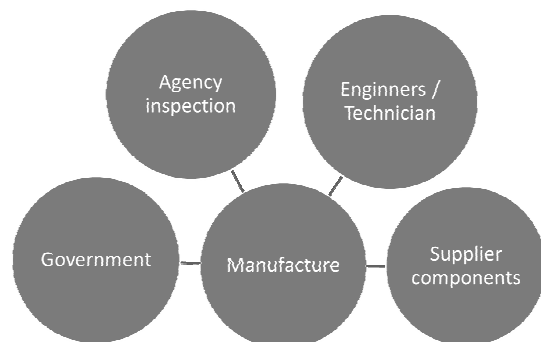

Figure 4. Stakeholders of product: Production Process.

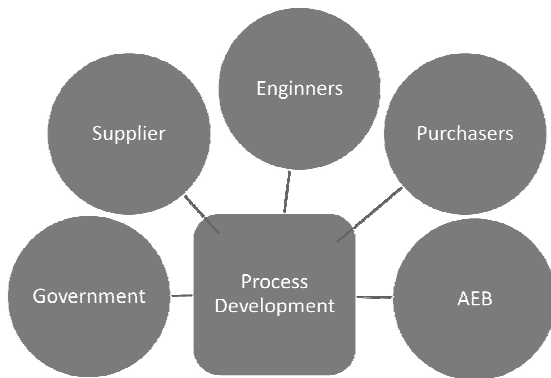

Figure 5: Stakeholders of Organization: Development Process.

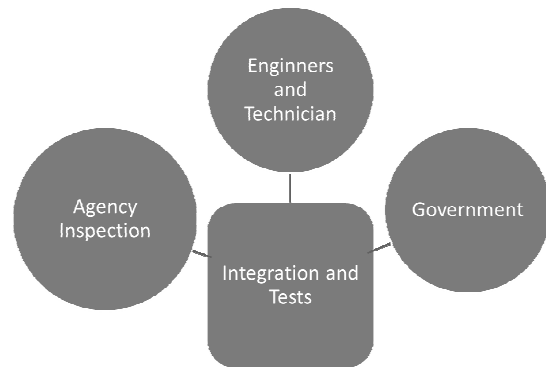

Figure 6: Stakeholders of Organization: Integration and Tests Process.

After identifying the stakeholders, their interests were defined in each process. And for one stakeholder in each analysis metrics – something that affects directly the interest – and measures – for measuring the metrics – were pointed out. Tables 1 to 4 show those relations.

Table 1. Metrics and measures for the process of operation (Control Center).

Stakeholders	Interests	Metrics	Measures of effectiveness
Control Center	Periodic flow of information (attitude and orbit); Control of attitude and orbit.	Positioning	Altitude (km); Orientation (rad) angular velocity (rad / s); Velocity around three axes (pitch, roll, yaw).

Table 2. Metrics and measures for the process of production (Regulamentary Institutions).

Stakeholders	Interests	Metrics	Measures of effectiveness
Regulamentary Institutions	Standard conformity	Mechanical architecture	Height (m); Length (m); Width (m); Weight (kg); Decomposition time (years); Natural frequency (Hz); Relationship strength / weight.
		Index of conformity	Percentage of compliance (%)

Table 3. Metrics and measures for the process of integration and tests (Engineers and technicians).

Stakeholders	Interests	Metrics	Measures of effectiveness
Engineers / technicians	Assessment of the product	Efficiency; Readiness; Accreditation.	Time (years); Reliability; Cost.

Table 4. Metrics and measures for the process of development (Government).

Stakeholders	Interests	Metrics	Measures of effectiveness
Government	Technological innovation	Innovative products	Number of products
	Appropriate application of resources	Accomplishment budget and execution plan	Total spending on planned spending; Completed on planned.

The context and architecture diagrams were built for the product in operation. Both diagrams complement each other, and show the physical and informational relations of the AOCS with the environment and other subsystems.

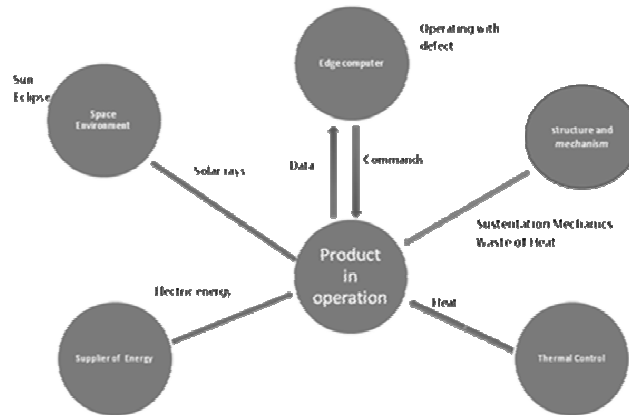

Figure 7. Context diagram for AOCS in operation.

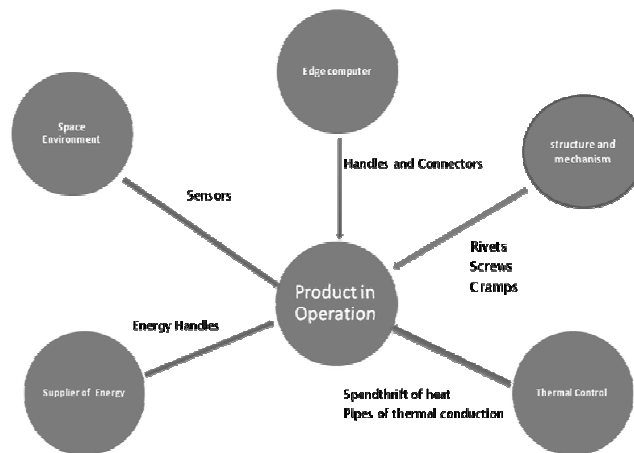

Figure 8. Architecture diagram for AOCS in operation.

Following the same line of thought of the context and architecture diagrams, the state transition and data flow diagrams elaborated considered the product (AOCS) in operation (figures 9,10).

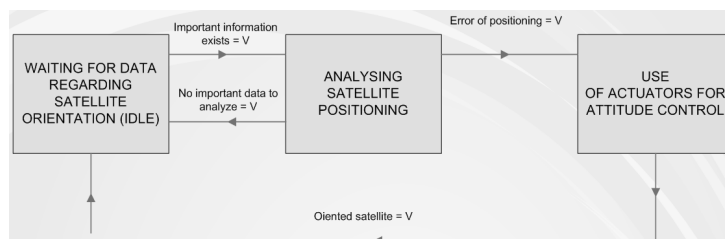

Figure 9. State transition diagrams for product in operation.

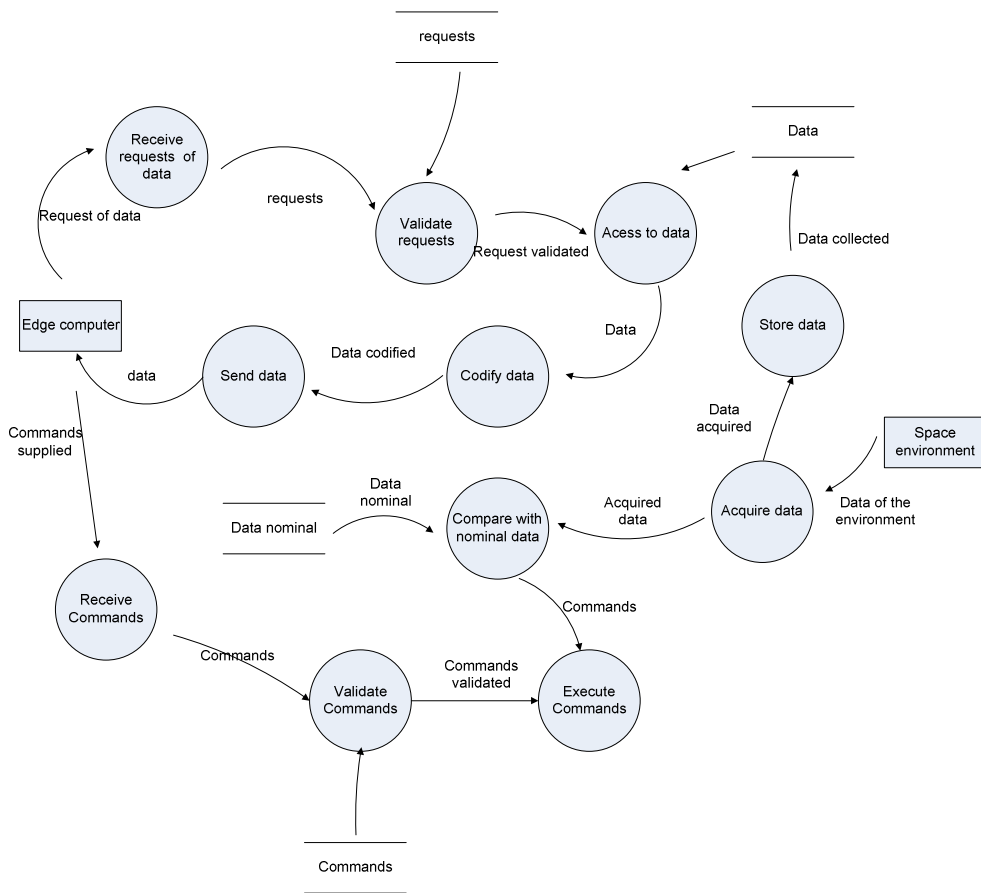

Figure 10. Data flow diagrams for the AOCS in operation.

The hazard analysis takes in consideration the physical connections in the context of architecture diagrams, the circumstances defined in the context diagram, and the data flow diagram. The main goal of such study is to point flaws and dangers that may occur in the life cycle of the product – AOCS. And also define the gravity, probability, risk and detection function for each case (table 5).

Table 5. Failure Analysis: AOCS in operation.

	Failure	Hazard	Gravity	Probability	Risk = G*P	Function	Function description
Power supply	Wear solar panel; Circuit failure; Defects in solar cells.	Lack of energy to power the subsystems.	4	1	4	Prevention	Control of energy distribution; Orientation of the solar panel.
Tracking errors	Data not identified.	Data loss; Command loss; Execution of unsolicited tasks.	1	3	3	Prevention	Redundancy in data storage.
Supports	Broken; Poor fixation.	Collision between the equipments; Subsystems loss.	2	1	2	Prevention	Use double protection system.
Thermal control	Breakdown in the thermal circuit; Damage to the sensor sensitivity.	Equipment failure due to fluctuation of temperature.	3	2	6	Detection	Notify changes in temperature fluctuation.
Electrical connection	Electromagnetic interference.	High tension; Curt circuit.	3	1	3	Protection	Disable equipment or subsystem where the crash occurred.
Heat sinks	Poor contact with heat sinks; Obstruction in the tubing of the fluid thermal.	Overheating; Leak.	2	1	2	Detection	Fluid level control.

The flow diagram emphasizes the material, energy and information flow between physical components of the subsystem AOCS (figure 11).

The interconnection diagram focus only in the physical relations between the components of the AOCS subsystem (cables, connectors, etc), giving a physical view of the product in operation (figure 12).

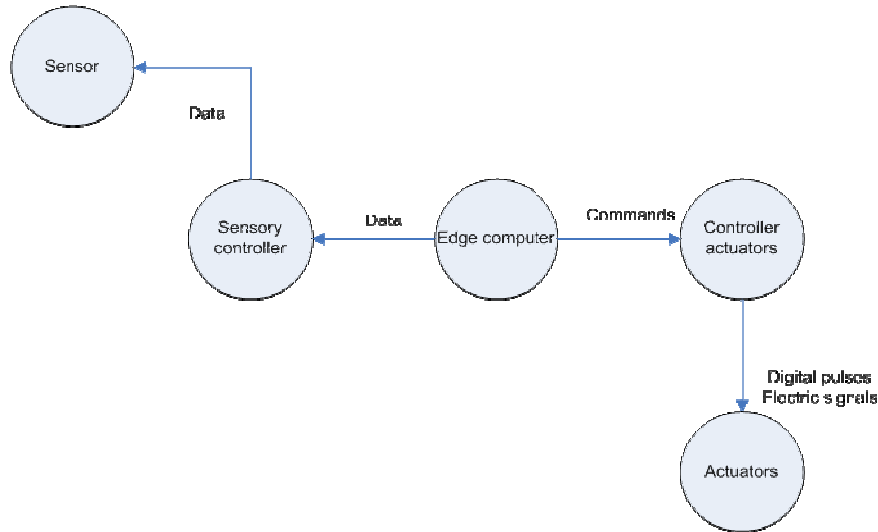

Figure 11. Flow diagram: product in operation.



Figura 12. Interconnection diagram: product in operation.

The final step of the method consists in elaborating an allocation matrix. This matrix relates all functions and parts responsible for them. Table 6 shows the allocation matrix for the product in operation

Table 6. Allocation matrix for product in operation

Function	Components				
	Sensor	Sensor controller	UCP	Actuators	Actuators controller
Receive data request			X		
Validate request			X		
Access data			X		
Encode data			X		
Send data			X		
Receive commands			X		
Validate commands			X		
Execute commands				X	X
Acquiring data	X	X			
Store data			X		
Compare with nominal data			X		

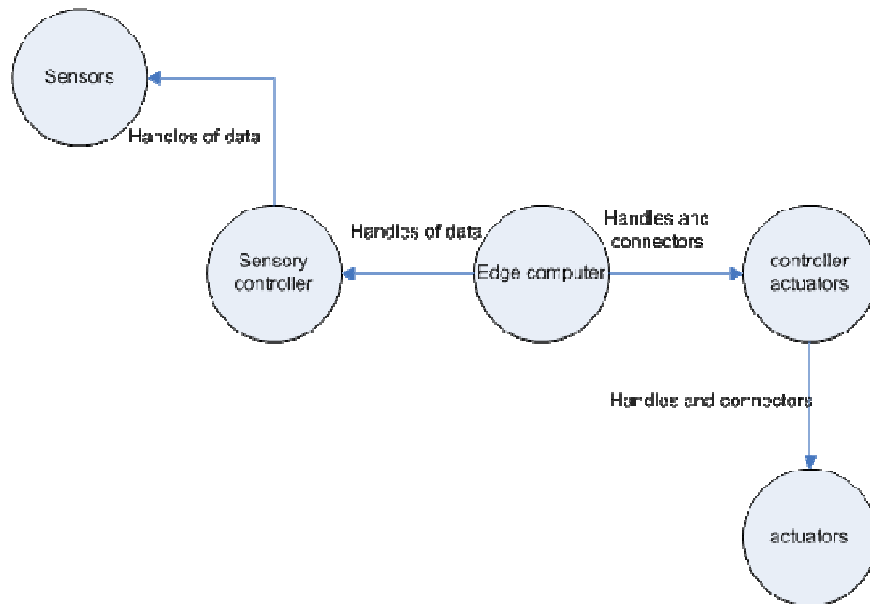
As can be seen in table 6, each component of the AOCS has one or more functions. This table helps to elaborate relations between functions and components, making easier to study failures that may occur in the system. The method shall be applied for the product in each of its life cycle process scenarios. In each scenario the organization that implements that scenario is also analyzed and its relationship with the product is captured. In this paper, for the sake of demonstration only, only the processes of operation, production, integration & testing and development were considered, but the method must be applied to all other life cycle processes and their scenarios.

5 Discussion

The parallelization of tasks permits a better view of the development process, since the early sketches to the end of the life cycle of the product. And different diagrams allow a more clear view of a particular aspect of the system. For example, a software engineer might be interested only in the flow of information for the design of the embedded software, ignoring other aspects, while an electrical engineer is interested in the relations between the system and its environment of operation, due to the relation between temperature and malfunction of electronic equipments. But, at the same time, it is important that all personnel involved in the development of the product realize that their job affects (and is affected) by the other professionals.

Stakeholder analysis is another point to be considered in concurrent engineering. The stakeholders provide important information that helps the developers to make clear requirements. Also, it is important that they are identified as soon as possible, as well as its metrics and measures, because this information will serve as a guide to all developers (engineers, technicians, administrators, suppliers, etc).

6 Conclusion

Through the use of Systems Concurrent Engineering methodology in the description of the AOCS the authors realized that it is essential to work in a systematic manner in order to obtain correct tables and diagrams that will allow engineers, technicians and administrators to take important decisions in the product and/or process development. Most important, the methodology makes possible the dialog between professionals with different backgrounds, thanks to relations built through several kinds of diagrams and tables.

One can detect easily flaws or critical points if the model of the process is built considering all interests involved. And finally, the use of the methodology and concepts of systems engineering makes it easier to eliminate unnecessary costs and accomplish deadlines.

Acknowledgements

The authors would like to thank INPE (the Brazilian Institute for Space Research, www.inpe.br) for the post graduate course opportunity.

References

Elfving, A., The Attitude and Orbit Control of XMM, ESA bulletin 100- December 1999, Directorate for Scientific Programmes ESTEC, Netherlands.

IEEE Guide for Developing System Requirements Specifications, IEEE Std. 1233-1996.

IEEE Recommended Practice for Software Requirements Specifications, IEEE Std. 830-1998.

Larson, Wiley J. and Wertz, James R., Space Mission Analysis and Design 1999, Version 3, ed. Kluwer Academic Publishers.

Loureiro G. A systems engineering and concurrent engineering framework for the integrated development of complex products. Ph.D. thesis, Loughborough University, 1999.